

1-1-2011

# Pleiotropic regulatory function of the lysr family transcriptional regulator cpsy during streptococcus iniae systemic infection

Jonathan Paul Allen  
*Wayne State University,*

Follow this and additional works at: [http://digitalcommons.wayne.edu/oa\\_dissertations](http://digitalcommons.wayne.edu/oa_dissertations)

 Part of the [Microbiology Commons](#)

---

## Recommended Citation

Allen, Jonathan Paul, "Pleiotropic regulatory function of the lysr family transcriptional regulator cpsy during streptococcus iniae systemic infection" (2011). *Wayne State University Dissertations*. Paper 300.

This Open Access Dissertation is brought to you for free and open access by DigitalCommons@WayneState. It has been accepted for inclusion in Wayne State University Dissertations by an authorized administrator of DigitalCommons@WayneState.

**PLEIOTROPIC REGULATORY FUNCTION OF THE LysR FAMILY TRANSCRIPTIONAL  
REGULATOR CpsY DURING *STREPTOCOCCUS INIAE* SYSTEMIC INFECTION**

by

**JONATHAN P. ALLEN**

**DISSERTATION**

Submitted to the Graduate School

of Wayne State University,

Detroit, Michigan

in partial fulfillment of the requirements

for the degree of

**DOCTOR OF PHILOSOPHY**

2011

MAJOR: IMMUNOLOGY AND MICROBIOLOGY

Approved by

Advisor	Date
_____	_____
_____	_____
_____	_____
_____	_____

## ACKNOWLEDGEMENTS

Obtaining a Doctor of Philosophy degree is not an individual accomplishment, but truly due to the combined effort and support of many. I would first like to express my most sincere thanks to my advisor Dr. Melody Neely, whose support, encouragement and mentorship was invaluable. Her excitement for our projects permeates the lab and engenders the same feelings within us all. I appreciate the scientific freedom that was permitted for exploration into many of the intricate and complex details discussed in this work. I would like to thank the members of my dissertation committee: Dr. Jeffrey Withey, Dr. Roy Sundick and Dr. Patricia Brown. Our meetings were always very productive, and their critiques of my work were extremely insightful. I couldn't have hoped for a better committee.

I owe a special thanks to our lab manager Donna Runft, whose patience with students is unparalleled and general knowledge within the lab is invaluable. I would like to thank all of the members of the lab: Dr. Jesse Miller and Dr. Beth Lowe who began this project and established a strong platform for me to begin my work; Dr. Hillary Phelps whom I did not overlap with, but, along with all the previous students, clearly established a strong precedence for the lab; Dr. Anne Kizzy and Dr. Jib Namprachan who are not only extremely talented and bright scientists but also wonderful friends; and Brett Hanson and Hannah Rowe whom I have enjoyed my time with in the lab and wish the best in their future endeavors.

I would like to thank the department chair, Dr. Paul Montgomery, for his leadership and support for all of the members of this department. To the administrative staff, Lynette Rae, Nancy Hynous and Mary Dismuke whose effort behind the scenes allows us all to focus on our work. The department is fortunate to have a group of amazing faculty who are always available and willing to discuss any issues that students have. I have appreciated their support and critiques of my work during my time here. I would like to thank Dr. Mark Stout and Ron Barrett for their technical support and help my research. I would also like to acknowledge all of the students of the department and many

from the school of medicine whom have become both friends and colleagues. I appreciate both the scientific discussions that have taken place in and out of the classroom as well as the fun times we've shared away from Scott Hall. They are an amazing group of individuals.

Finally I could have never made it to this point in my life without the support and love of my family. My parents Richard and Rosalie have always encouraged me to do what I love, and have been there to support and guide me through all of the challenges along the way. My brother Jeffrey and sisters Sarah and Susanna are my closest friends. I enjoy every moment we all spend together. I appreciate the patience and understanding of my family, and am excited to share this accomplishment with them.

## TABLE OF CONTENTS

Acknowledgements	ii
List of Tables	v
List of Figures	vi
Chapter 1 “General Introduction”	1
Chapter 2 “The <i>Streptococcus iniae</i> transcriptional regulator CpsY is required for protection from neutrophil-mediated killing and proper growth in vitro”	20
Introduction	21
Materials and Methods	23
Results	30
Discussion	57
Chapter 3 “CpsY-dependent protection from neutrophil-mediated killing involves modification and stabilization of the <i>Streptococcus iniae</i> cell wall”	62
Introduction	63
Materials and Methods	65
Results	71
Discussion	87
Chapter 4 “General Conclusions”	95
References	103
Abstract	139
Autobiographical Statement	141

## LIST OF TABLES

Table 1: Orthologs of the methionine metabolism and transport pathways	36
Table 2: Relative <i>atmB</i> expression for $\Delta cpsY$	37
Table 3: Minimal Inhibitory Concentration ( $\text{mg ml}^{-1}$ )	75
Table 4: <i>S. iniae</i> qPCR results	78
Table 5: Peptidoglycan acetylation	79
Table 6: Muropeptide percent composition	81

## LIST OF FIGURES

Figure 1: Schematic of metabolic pathways associated with single-carbon unit flow	14
Figure 2: Capsule synthesis operon map of <i>S. iniae</i>	18
Figure 3: Serum growth curves	31
Figure 4: Effect of methionine on bacterial growth	32
Figure 5: Effect of proteose peptone on bacterial growth	33
Figure 6: Schematic of streptococcal methionine biosynthesis and uptake pathways	35
Figure 7: Promoter alignment for the <i>atmBDE</i> cluster	39
Figure 8: Images of tissue homogenates from <i>S. iniae</i> -infected zebrafish	40
Figure 9: <i>S. iniae</i> macrophage infections	42-43
Figure 10: Live/Dead® fluorescent staining of <i>S. iniae</i> -infected macrophages	44
Figure 11: Macrophage apoptosis	46
Figure 12: qPCR of <i>S. iniae</i> -infected macrophages	47
Figure 13: Macrophage apoptosis of <i>S. iniae</i> culture supernatant-treated cells	49
Figure 14: Macrophage apoptosis	50
Figure 15: Macrophage apoptosis of cells treated with culture supernatants from a panel of bacteria	51
Figure 16: <i>S. iniae</i> survival in human whole blood	53
Figure 17: <i>S. iniae</i> neutrophil infections	54
Figure 18: Images of <i>S. iniae</i> neutrophil infections	55
Figure 19: <i>S. iniae</i> colocalization with neutrophil granule markers CD107A and CD63	72
Figure 20: Neutrophil competition assay	73
Figure 21: Measurement of bacterial cell surface charge	76
Figure 22: Bacterial growth curves	83
Figure 23: <i>S. iniae</i> survival in human whole blood	84
Figure 24: Promoter alignment for CpsY-regulated genes	86

## CHAPTER 1

### General Introduction

**Invasive streptococcal pathogens are a global health concern.** Streptococcal pathogens continue to pose significant challenges for the treatment and prevention of invasive disease worldwide (96, 218, 228, 258). The emergence of antibiotic resistance among streptococcal isolates adds to the relevance of this problem (151, 252). Those at highest risk for invasive streptococcal disease include young children, the elderly and the immunocompromised (228). The major human streptococcal pathogens associated with severe morbidity and mortality include *Streptococcus pyogenes*, *Streptococcus agalactiae*, and *Streptococcus pneumoniae*. These species are often asymptotically carried on the nasal, oral or vaginal mucosal surfaces, and can easily be transmitted to others. For example, vaginal colonization of *S. agalactiae* is a precondition for *in utero* transmission to newborns (49).

Infections of *S. pyogenes* (group A streptococcus, GAS) can manifest as acute symptoms including pharyngitis, cellulitis and pyoderma to more invasive diseases such as necrotizing fasciitis, sepsis, pneumonia and streptococcal toxic shock syndrome (188). Additionally non-suppurative sequelae such as acute rheumatic fever and glomerulonephritis can complicate recovery efforts even after the infection has been resolved (69). The recent resurgence of invasive GAS infections has impacted many populations of the world (50), and placed huge economic burdens in both developing and developed countries, with cost estimates up to \$500 million per year in the United States alone (227).

*Streptococcus agalactiae* (group B streptococcus, GBS) is a significant cause of morbidity and mortality in both newborns, the elderly and immunocompromised (25, 293). Neonatal GBS disease can manifest as either early onset with symptoms including respiratory failure and pneumonia progressing into bacteremia and septic shock, or late onset which is characterized as a bloodstream



infection with high risk of meningitis (207). While advancements in diagnosis and prophylactic treatment have reduced early-onset neonatal mortality (78), the persistence of *S. agalactiae*-related still births, prematurity and late-onset disease remains a significant problem (107, 255). Additionally, an increased incidence of skin infections, pneumonia and bacteremia among the elderly and immunocompromised (83, 97), along with an emerging resistance to penicillin, clindamycin and erythromycin among individual isolates is cause for concern (123, 150, 263).

*Streptococcus pneumoniae* is a major cause of otitis media in children, as well as invasive diseases including pneumonia with bacteremia and/or empyema, and meningitis in newborns and the elderly. The World Health Organization estimates that 1 million children die of invasive pneumococcal disease every year, mostly in developing countries (309). Moreover, pneumococcal infections are the leading cause of death from a vaccine-preventable illness in children < 5 years of age (52). As with the other streptococcal pathogens, a huge economic burden is associated with *S. pneumoniae* infection despite current vaccination efforts (280). A licensed 23-valent pneumococcal polysaccharide vaccine has been in use since the late 1970s for the prevention of adult pneumococcal bacteremia (59); however, the burden of adult nonbacteremic pneumococcal pneumonia remains a significant challenge.

Because the adult polysaccharide vaccine is not effective in children < 3 years of age, conjugate vaccines were developed for use in newborn vaccinations. The first licensed multi-valent pneumococcal vaccine for newborns (PCV7) was composed of polysaccharides from 7 different *S. pneumoniae* serotypes conjugated to the diphtheria toxoid. PCV7 vaccination programs were initially extremely successful with not only significant reductions in invasive pneumococcal disease, but also a decreased frequency of antimicrobial resistant pneumococci (133). The selective pressure imparted by PCV7 vaccination resulted in the emergence of new clinically relevant serotypes including the severe multi-drug resistant serotype 19A (70, 128), such that by 2010 the Centers for Disease Control and Prevention reported that 63% of invasive pneumococcal disease in children < 5 years of age was due to

non-PCV7 protected serotypes (53). The vaccine was recently reformulated and licensed for protection against 13 clinically relevant serotypes (1, 3, 4, 6A/B/C, 7F, 9V, 14, 18C, 19A/F and 23F) (1-2); however, there are 96 documented pneumococcal serotypes with varying capsular polysaccharide structures categorized into 46 different serogroups based on immunological cross-reactivity (118, 261). Thus the possibility for new and emerging variants still exists.

Although there are no licensed vaccines for either *S. agalactiae* or *S. pyogenes*, significant developmental efforts have been undertaken. Five GBS serotypes (Ia, Ib, II, III, V) account for 96% of neonatal cases and 88% of invasive GBS disease in adults (229, 315). Vaccines for all the 5 major capsular polysaccharide serotypes conjugated to tetanus toxoid have been constructed and show enhanced immunogenicity in early clinical trials (11-15, 220); however, the emergence of new serotypes is also a concern as observed with *S. pneumoniae*. Additional surface molecules such as the Sip protein and immunogenic proteins from the GBS pilus are being investigated for their effectiveness as alternative vaccine targets to the capsular polysaccharide (38, 137, 193).

The lack of a clear strategy for primary protection against *S. pyogenes* infection strengthens the need for an effective GAS vaccine (270). The most advanced vaccine in development is both multivalent and type specific, made of short tandem peptides from the N-terminal region of the major surface M-protein (130). The *S. pyogenes* M protein has long been investigated for GAS vaccine design; however, early observations related to the cross-reactivity of protective antibodies with human tissues such as heart (72) brain (40), kidney or joint cartilage (10) led to initial concerns about vaccination safety, though many of these concerns have been addressed in current formulations. Additional pitfalls of this current vaccine relate to the high antigenic variability of the M protein (99, 138). Epidemiological studies of endemic populations with high GAS disease prevalence show extensive variability in M serotypes (146, 239). One study in particular identified 31 different GAS M serotypes within a small Australian Aboriginal community over a 2 year period, with up to 11 different serotypes occurring at any given time (27). Such variability could hinder the vaccine efficacy,

especially in countries with high endemic GAS disease (270). Other vaccines currently in development target the conserved C-repeat region of the M protein (35-36, 238), the conserved GAS carbohydrate (129), C5a peptidase (136), streptococcal fibronectin-binding protein 1 (Sfb1) (292) and streptolysin S (73), though most are far from clinical trials.

As outlined above, invasive streptococcal pathogens present a significant public health concern. Problems with treatment and prevention of invasive human streptococcal pathogens emphasize the importance of understanding both mechanisms of streptococcal pathogenesis and surface adaptations for the design of efficient vaccines and treatment options. The use of model streptococcal pathogens such as *Streptococcus iniae* to address these issues may prove invaluable for the identification of novel vaccine targets and development of effective therapeutics. The use of *S. iniae* to investigate the challenges that exist for infection control of streptococcal pathogens is discussed in greater detail in the following sections.

***Streptococcus iniae* is an invasive systemic pathogen and model pathogen.** *Streptococcus iniae* is a  $\beta$ -hemolytic, Lancefield serogroup negative, Gram positive streptococci originally isolated from the subcutaneous abscess of an Amazon freshwater dolphin (*Inia geoffrensis*) suffering from acute “golf ball disease” (231-232). Aquatic species infected with *S. iniae* typically suffer from severe skin lesions, septicemia and meningoencephalitis (9). Disease epidemics are often associated with seasonal increases in water temperature or poor water quality (22, 39, 144). Streptococcosis of fish was not widely observed prior to the 1970s (247); however, the increased use of aquaculture for maintaining fish populations has resulted in the pandemic spread of *S. iniae*, with documented outbreaks affecting approximately 30 different aquatic species and losses totaling \$100 million annually (4).

The enormity of loss associated with *S. iniae* outbreaks prompted the development of a formalin-killed vaccine (90), and its successful implementation in large farming operations provided

significant relief for trout fisheries within Israel (22). This success was short-lived when within 2 years the emergence of an unprotected strain with altered serotype specificity resulted in massive outbreaks in previously vaccinated fish populations (7, 19, 165). Reformulation of the vaccine was again followed by the emergence of a new variant that produced copious amounts of extracellular polysaccharides (EPS) (94). The new EPS producing strains were hyperinflammatory and displayed an increase in disease severity and mortality (93). Thus development of a reliable vaccine for *S. iniae* has been challenging and will require a better understanding of streptococcal surface variability (4). The emergence of unprotected strains of *S. iniae* following large scale vaccination equates to the problems observed with human vaccination against *S. pneumoniae* (128). Testing the efficacy of novel streptococcal vaccine targets using *S. iniae* could be an efficient way to determine their long term effectiveness in large populations under strong selective pressure, minimizing the emergence of unprotected variant strains. Such targets could then be further validated for their effectiveness against human streptococcal pathogens. Novel targets for *S. iniae* vaccine development that are currently being investigated include a putative iron binding protein Sip11 (58), hydrophobic membrane protein MtsB (320) and a DNA based vaccine expressing a secretory antigen Sia10 under the control of a cytomegalovirus immediate-early promoter (278).

The specific identification of *S. iniae* among fish populations for epidemiologic monitoring has been difficult due to its similarity to several other streptococcal species including *Streptococcus parauberis* and *Streptococcus difficilis*. Thus even PCR based diagnosis toward various targets including the 16S rRNA gene, chaperonin HSP60 or the 16S-23S rRNA intergenic region has been problematic (26, 109, 319). A breakthrough occurred when a *S. iniae* gene encoding a lactate oxidase (*lctO*) was identified, and found to be limited to a few streptococcal species such as *S. equi* and *S. pyogenes* (108). Novel primer sets were designed (LOX1/LOX2) which allowed for the specific identification of *S. iniae* through PCR amplification of *lctO* (194), providing a tool for determining the presence of *S. iniae* in large aquaculture systems. During random screening of a fish farm in Northern

Australia, a novel *lctO* variant was identified that produced a larger, more efficient version of the enzyme, which may provide a competitive advantage against other *S. iniae* strains (212). Examples such as this highlight the selective pressures placed on emerging pathogenic strains in aquaculture, and underscore the importance of developing efficient identification and control strategies.

Documented cases of zoonotic *S. iniae* infection began in the mid 1990s when in the span of a year 4 patients developed bacteremic cellulitis from injuries obtained while handling fresh fish (304). Since then sporadic cases have been documented worldwide, all occurring after injury from infected fish (95, 171, 277, 305). Human clinical isolates of *S. iniae* show increased virulence in animal infection models compared to commensal fish strains (101). Furthermore, recent human isolates display enhanced survival and replication over earlier isolates when cultured in whole blood (95). Nonetheless, *S. iniae* is not considered an emerging pathogen of human concern (95, 260).

*S. iniae* has been used as a model pathogen for the study of systemic streptococcal infection in several native hosts including hybrid striped bass (42, 44), rainbow trout (18, 41, 88), barramundi (8), tilapia (88, 320) and zebrafish (202-203, 214). Numerous virulence factors have been described that severely influence the morbidity and mortality caused by this pathogen. Many of these factors are also critical for virulence of human streptococcal pathogens as well, providing relevance for the use of *S. iniae* as a model pathogen for the study of invasive streptococcal infection.

In concordance with many invasive pathogens, the majority of virulence factors described for *S. iniae* protect against opsonophagocytic killing by neutrophils (81, 110, 196, 306). *S. iniae* contains a homolog of the major streptococcal M protein, which can bind fibrinogen as well as the FC region of immunoglobulin to inhibit opsonization (8, 18). *S. iniae* also produces a C5a peptidase to hydrolyze the neutrophil chemoattractant complement factor C5a (180); however, unlike the *S. pyogenes* homolog, the *S. iniae* protein is not observed in cultured supernatants, and mutants show no attenuation in vivo suggesting a minor pathogenic role. The streptolysin S cytolysin (SLS) of *S. iniae* is homologous to that of *S. pyogenes* and contains hemolytic activity against erythrocytes, lymphocytes

and neutrophils (102). Furthermore, expression of the *S. iniae* homolog in an *S. pyogenes* SLS mutant restored hemolytic activity (181). Expression of the SLS locus appears to be controlled by the SivSR two-component signal transduction system (TCS) (31). SivSR also regulates the *cfi*-encoded pore-forming toxin CAMP factor (31), and has been shown to influence capsule production as well (30).

*S. iniae* produces a complex polysaccharide capsule that facilitates protection from opsonophagocytic killing. The genes required for capsule biosynthesis are encoded in an operon of approximately 21 kbp in size (185) that is transcriptionally controlled by the conserved CpsA regulator, a member of the LytR\_cpsA\_psr family (117). Deletion of *cpsA* results in reduced capsule biosynthesis and severe attenuation in vivo (185). The capsule operon was initially characterized following transposon mutagenesis studies performed on two separate strains of *S. iniae*: strain 9117, isolated from a human patient with bacteremic cellulitis (305), and strain NUF631, isolated from a diseased Japanese flounder (*Paralichthys olivaceus*) (262). Both studies reported that transposon insertions affecting capsule production occurred within the same sets of genes: *cpsH*, *orf276* and *cpsM*, with one additional mutant in *cpsK* for 9117, suggesting either the importance of these genes in capsule production or the amenability of these regions for transposon insertion. All capsule mutants from strain NUF631 were shown to have decreased capsule production accompanied with decreased survival in whole blood and macrophages (262). Mutants in either *orf276* or *cpsH* of strain 9117 displayed a similar reduction in capsule production and increased susceptibility to killing in whole blood (185, 202). In contrast, the *cpsM* mutant of strain 9117 displayed a significant increase in capsule production with an accompanying increased survival in whole blood (185). Additionally, none of the 9117 capsule mutants were found to be susceptible to macrophage-dependent killing (202). The difference in macrophage susceptibility between 9117 and NUF631 is most likely due to strain differences, as human isolates tend to be more virulent than those from fish (101); however the reason for the inverse phenotypes related to mutations in *cpsM* is still unclear. CpsD has also been studied for its role in capsule production, and mutants display similar phenotypes to those of *cpsH*, including

reduced capsule production, sensitivity to cationic antimicrobial peptides and an increased susceptibility to killing in whole blood (182).

*S. iniae* is a strong candidate for use as a model pathogen to study invasive streptococcal disease. The prevention challenges, disease invasiveness and myriad of virulence determinants are homologous to those observed with human streptococcal pathogens. The knowledge gained from utilizing *S. iniae* as a model pathogen could enable direct comparison for use in control of human streptococcal pathogens. Moreover, the use of a natural host such as the zebrafish to investigate disease pathogenesis and infection control could be a powerful and cost-effective tool when fishing for the ultimate therapeutic strategy.

**Zebrafish as a biological model system.** The zebrafish (*Danio rerio*) is a tropical freshwater fish that has emerged as an important tool for biological studies. Their small size, relative low cost and ease of breeding allows for studies to be performed in large scale. Zebrafish have been used for studying diverse areas of biology including vertebrate development (46, 85, 219), aging (152), cardiovascular disease (54), cancer (178, 223), neuroscience (141, 246) and toxicology (127, 176, 213). Zebrafish have also proven to be a powerful tool for investigations into immune system development, function and disease (197, 276). The zebrafish immune system is closely related to that of humans, with both functional innate and adaptive arms (198, 208, 271, 276, 284-285). Zebrafish do not have a fully functional adaptive immune system until around 4 to 6 weeks of development (167-168), which offers a unique opportunity to study the functional role of innate immune components in the absence of adaptive immunity. Moreover, with a complete sequenced genome, useful tools for forward and reverse genetic techniques, gene silencing as well as inducible transgenics, new applications for this unique model organism are constantly emerging (6, 71).

Several technologies for genetic manipulation of the zebrafish make it a useful system for disease investigation. Gene silencing using morpholinos continues to be a valuable tool for investigating gene function. Morpholinos are modified antisense oligos that are similar to DNA and

RNA oligonucleotides, except that they have a morpholine rather than a ribose ring and are thus extremely resistant to nucleases. Morpholinos are micro-injected into embryos and decrease or silence expression of a specific target gene by either blocking translation initiation or inhibiting splicing (80, 86, 210). The generation of zebrafish mutants can be done by chemical mutagenesis using agents such as ethylnitrosourea (ENU). Heterozygous germ line mutations for a specific phenotype can be mapped by Targeting Induced Local Lesions in Genomes (TILLING) (79, 273). Additionally, retroviral or transposon insertion libraries can be made by injecting retroviral constructs into blastula-staged embryos, generating chimeric embryos in which clones of cells within the embryo contain different insertions (5, 147). Insertions in cells that ultimately form the germ line are transmitted to the next generation, and harvested sperm can be used to prepare genomic DNA for sequencing around the insertion. Furthermore, technologies for using inducible transgenes have also been proven effective in zebrafish. Tissue specific promoters can be used to drive expression of the reverse-Tet-controlled transactivator (rtTA). In the presence of Doxycycline, the rtTA protein can then bind to a second rtTA-responsive element to drive expression of a gene of interest or reporter gene, such as green fluorescent protein (131). Alternatively the Cre/loxP system, which is traditionally used for the generation of conditional mutants, has been used in zebrafish for transgene induction. In such a system, tissue specific promoters drive expression of the Cre-recombinase, whereby a loxP-flanked element within a promoter region is removed for reporter gene expression or expression of a gene of interest (221). Additionally zebrafish larvae remain translucent for several weeks. Taking advantage of this trait, zebrafish strains have been created in which macrophages and neutrophils express green fluorescent protein, thus allowing for real-time imaging of the behavior of these cell types to various stimuli in vivo (177). The ability to easily manipulate either the pathogen or the host for the study of infectious disease, as well as real time imaging of disease progression could allow for unprecedented insight into the host-pathogen interactions that occur during invasive infectious disease.



The zebrafish has been a useful tool for the identification of streptococcal virulence genes through large-scale mutagenesis of streptococcal pathogens. In separate signature-tagged mutagenesis (STM) studies performed on *S. iniae* and *S. pyogenes*, 12 individually tagged STM vectors were used to generate separate libraries from which individual mutants were pooled and injected into zebrafish (153, 202). At specific time points tissues were removed and screened by PCR for the presence/absence of the specific mutants based on the individual STM tag. Mutations in genes required for survival in the host were identified by the presence of the mutant in broth culture, but not in tissue homogenates. This successful technique identified several novel streptococcal virulence factors, and highlighted the importance of several previously characterized systems.

Zebrafish have also been used to investigate complex host/pathogen interactions involving macrophage recruitment, granuloma formation and spread of *Mycobacterium marinum*. The ESX/RD1 secretion system locus of *M. marinum* was found to be involved in granuloma formation (296) through the active recruitment of host macrophages to the expanding granuloma (75). The 6 kDa early secreted antigen target (ESAT6) secreted by the RD1 locus was determined to induce production of matrix-metalloproteinase 9 (MMP9) in neighboring epithelial cells. The induction of MMP9 is what triggers macrophage recruitment and granuloma expansion, which is critical for mycobacterial spread (297). Virulence properties of several other pathogens have been studied using zebrafish infection models including bacterial pathogens such as *Salmonella typhimurium* (274), *Pseudomonas aeruginosa* (62, 230), *Francisella* sp. (295) and *Edwardsiella tarda* (236), as well as viral pathogens such as the Infectious Spleen and Kidney Necrosis Virus (310) and Herpes Simplex Virus 1 (132).

**Polymorphonuclear granulocytes.** Neutrophils, or polymorphonuclear leukocytes, are extremely important for protection against microbial pathogens. Neutrophils are professional phagocytic cells which eliminate microbes through a variety of bactericidal mechanisms (256). Patients with congenital neutropenia or chronic granulomatous disease, or who display increased neutrophil destruction due to chemotherapy are at an increased risk for severe fungal and bacterial

infections (191). Neutrophils are produced from myeloid precursors in the bone marrow in large number and circulate in the blood stream at concentrations ranging from 3 to 6 million cells per ml in healthy individuals (175). They are easily identified after Giemsa staining by their characteristic multi-lobed nucleus and large concentration of cytoplasmic granules. The neutrophil granules contain clusters of antimicrobial and cytotoxic substances that are delivered to the phagosome or to the exterior of the cell during degranulation.

If microorganisms circumvent the physical barriers of the skin or mucous membranes, neutrophils are rapidly recruited to the site of infection by responding to chemotactic signals produced by neighboring cells and vascular endothelium nearest the infection site (243). Neutrophils escape circulation through a series of sequential events that begin with initial weak “slow rolling” interactions of selectins on both the neutrophil and activated vascular endothelial surfaces (308). This is followed by firm adhesion to the endothelial surface through interactions involving neutrophil  $\beta_2$ -integrins and the endothelial immunoglobulin superfamily members Inter-cellular Adhesion Molecule (ICAM) -1 and ICAM-2. Strong adhesion triggers morphological changes for the neutrophil in preparation for diapedesis. A collection of endothelial adhesion molecules including ICAM-1 and -2, Junctional Adhesion Molecules (JAM), Endothelial cell Selective Adhesion Molecule (ESAM), and several cadherins interact with similar molecules on the neutrophil cell surface to both assist in neutrophil paracellular migration as well as stabilization of the endothelial cell junction. Neutrophils traverse the basal membrane and tissues by breaking down the connective tissue with several enzymes including elastases and matrix metallo proteinases (308).

Neutrophils in tissue display an increased phagocytic capacity compared to when in circulation (267). They also produce various chemokines for recruitment of additional inflammatory cells. Neutrophils phagocytose and kill microbes through a complex series of events which begin with the pathogen being engulfed into a early phagosomal vacuole (172). Pathogens within the nascent

phagosome are exposed to a burst of reactive oxygen species following assembly of the NADPH oxidase. This is followed by a series of maturation events which involve a reduction of phagosomal size and successive fusion of the pre-formed gelatinase, specific, and azurophilic granules (172, 256). These granules deliver a diverse arsenal of bactericidal compounds including various antimicrobial peptides, proteases and lysozyme in an attempt to eliminate the pathogen (98).

Neutrophils are also able to undergo a very specific type of programmed cell death (netosis) that requires components of autophagy and the generation of superoxide, leading to the release of a DNA/histone containing net-like extracellular trap (244). These neutrophil extracellular traps (NETs) are able to contain invading pathogens in a mesh-like network to limit bacterial spread (37). Mass spectrometry analysis of NETs reveals the association of 24 different cationic bactericidal proteins within the NETs (288). NETs have been demonstrated to play a significant role in protection against several pathogens including *Leishmania amazonensis* (112), *Candida albicans* (288), *Aspergillus fumigates* (195) and *Haemophilus influenzae* (140). Several pathogens including *S. pyogenes* (56), *S. pneumoniae* (204) and *Staphylococcus aureus* (23) have been shown to produce extracellular DNases thought to dissolve NETs and promote bacterial spread.

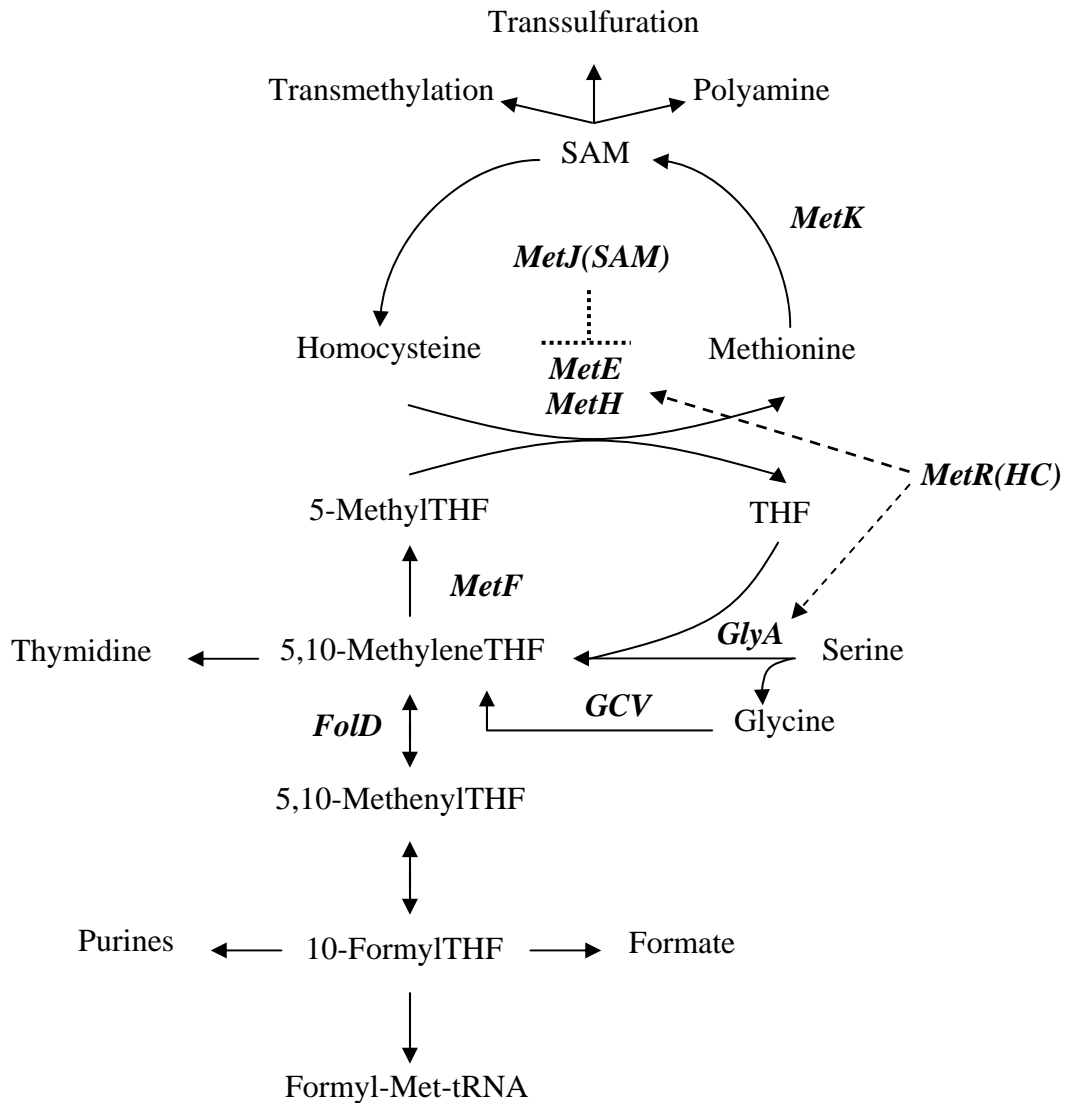
**Methionine and single carbon metabolism.** The transfer of single carbon groups (i.e. methyl/formyl groups) is an important chemical modification for compounds involved in a myriad of cellular processes. These single carbon (C<sub>1</sub>) units are carried throughout the cell by tetrahydrofolate (THF), a reduced form of folic acid. C<sub>1</sub>-THF derivatives are involved in single-carbon transfer reactions for the synthesis of purines, formylmethionyl-tRNA, thymidylate, pantothenate, glycine, serine and methionine (76, 190). Sulfonamides are antibacterial compounds that target the enzyme dihydrofolate reductase (DHFR) involved in the synthesis of THF, and are thus effective broad-spectrum antimicrobials due to the variety of downstream pathways affected by THF deficiency (119).

THF primarily accepts methyl groups from serine, by the action of the serine hydroxymethyltransferase (GlyA), or glycine, by the glycine cleavage complex (GCV), to form 5,10-

methyleneTHF, which is the central compound in C<sub>1</sub> metabolism (Fig. 1). 5,10-methyleneTHF can either donate a C<sub>1</sub> group directly for synthesis of thymidine nucleotides, be oxidized by NADP<sup>+</sup> to form 5,10-methenylTHF involved in purine nucleotide biosynthesis, or can be reduced by NADPH to 5-methylTHF for the biosynthesis of methionine (76).

Biosynthesis of methionine involves metabolic pathways for de novo biosynthesis of cysteine, which is then converted to homocysteine through a cystathionine intermediate. The methyl group of 5-methylTHF is transferred to homocysteine to form methionine by the action of either the cobalamin-independent methionine synthase (MetE) (82), or cobalamin-dependent methionine synthase (MetH) and Vitamin B<sub>12</sub> (16) (Fig. 1). Methionine is not only an important amino acid in translation and protein synthesis, but is also the precursor for the synthesis of *S*-adenosylmethionine (SAM). SAM is produced from methionine and adenosine-triphosphate (ATP) by the action of *S*-adenosylmethionine synthase (MetK). SAM is the primary methyl donor for transmethylation and transsulfuration reactions, as well as polyamine synthesis (186). *S*-adenosylhomocysteine is formed as a reaction product, and is rapidly converted back to homocysteine to be reused in the synthesis of methionine, thus completing the methyl cycle.

Regulation of methionine biosynthesis has been best characterized in Gram negative organisms. MetJ is a transcriptional repressor that binds excess SAM as a cofactor to repress transcription of the de novo methionine biosynthesis genes when methionine levels are sufficient (Fig. 1) (169). This transcriptional repression is relieved under sulfur limiting conditions when SAM levels drop and methionine biosynthesis is required for synthesis of SAM (113). Additionally, a LysR family transcriptional regulator, MetR, utilizes homocysteine as a cofactor to compete with the MetJ:SAM complex and increase methionine biosynthesis through transcriptional activation of *metE* and *metF* due to a buildup of homocysteine (Fig. 1) (47, 65, 183, 234, 290-291). MetR also activates expression of the GlyA serine hydroxymethyltransferase to increase synthesis of 5,10-methyleneTHF for downstream use in methionine biosynthesis (234).



**Figure 1.** Schematic of metabolic pathways associated with single-carbon (C<sub>1</sub>) unit flow. This diagram represents possible outcomes for the C<sub>1</sub>-tetrahydrofolate (THF) derivatives, and how C<sub>1</sub>-THF derivatives are used for biosynthesis of methionine and ultimately S-adenosylmethionine (SAM). Only genes involved in metabolic processes discussed in the text are shown italicized in black. (*SAM*) and (*HC*) indicate the transcriptional regulators MetJ and MetR utilize S-adenosylmethionine and homocysteine as cofactors respectively. Solid arrows indicate enzymatic reactions, dashed arrows represent transcriptional activation, and the dashed line indicates transcriptional repression.

**Apoptosis.** Apoptosis is a natural pathway of programmed cell death that is utilized for maintaining homeostasis, as part of the developmental process of multicellular organisms, and by the immune system for removal of damaged or infected cells (316). Apoptosis can also be triggered under conditions of cell stress such as DNA damage or increased generation of reactive oxygen species (ROS). Activation of regulatory cascades leading to apoptosis occurs through both intrinsic and extrinsic pathways in the cell. In the intrinsic pathway, various stimuli occurring from cell stress can disturb the balance of Bcl-2 family proteins, which alter the mitochondrial transmembrane potential leading to the release of cytochrome *c* into the cytosol (163). Cytochrome *c* in the cytosol initiates activation of the apoptosome, which in turn triggers a signaling cascade resulting in the activation of the cysteine-dependent aspartate-directed protease 3 (caspase 3). Caspase 3 is the terminal caspase of the pro-apoptotic pathways and upon activation cleaves various targets to promote apoptotic death (77). In the extrinsic pathway, ligands such as Fas (FasL) or tumor necrosis factor alpha (TNF $\alpha$ ) bind to death receptors on the cell surface (253). Trimerization of bound receptors promotes recruitment of various adaptor proteins that ultimately leads to the activation of caspase-8/10, triggering a cascade of signaling events that leads to the activation of caspase 3 and subsequent apoptotic death . Apoptosis must be tightly regulated to ensure that spontaneous activation of these catastrophic pathways does not occur. Fas-induced apoptosis by the extrinsic pathway can be effectively blocked by proteins such as the Flice-Inhibitory Protein (FLIP), while apoptosis triggered from the intrinsic pathway is inhibited by stabilization of the mitochondrial membrane potential through Bcl-2 family proteins such as BclXL, or by the cytokine response modifier A (CrmA). In addition, activation of caspase-3 by either pathway can be blocked by inhibitor of apoptosis proteins (IAPs) such as XIAP, which bind directly to caspase 3 (122). Moreover, the protein kinase Akt can be activated by various growth factors to promote cell survival through phosphorylation-inactivation of the pro-apoptotic protein Bad, along with activation

of IKK $\alpha$  that ultimately leads to NF $\kappa$ B activation and subsequent expression of pro-survival genes such as FLIP and BclXL (122).

Many bacterial pathogens have evolved different strategies to either induce or inhibit apoptosis to promote their own survival (303). Pathogens such as *Shigella*, *Salmonella*, and *Listeria* have evolved strategies to induce apoptosis of phagocytic cells in order to escape phagolysosomal killing (105), while others such as *Mycobacterium*, *Chlamydia*, and *Coxiella* inhibit apoptosis using the intracellular environment as a protective niche (187, 303). Bacterial pathogens that inhibit apoptosis do so by a variety of strategies. *E. coli* K1 infection of murine macrophages results in expression of the pro-survival gene Bcl<sub>XL</sub> and blockage of cytochrome *c* release (275), whereas *Shigella flexneri* inhibits apoptosis in epithelial cells by directly blocking activation of caspase-3 (61).

*S. agalactiae* and *S. pneumoniae*-infected phagocytes have been shown to induce apoptosis by 48 hours post infection (287). In contrast, *S. iniae* (9117) has been shown to inhibit apoptosis in macrophages 24 hours post infection (184). Furthermore, two different isolates of *S. iniae* (9033 and 173) resulted in the inhibition of apoptosis in primary fish phagocytes (281). The contrasting results between *S. pneumoniae*, *S. agalactiae*, and *S. iniae* may be due to differences in the time points investigated as well as the experimental conditions. Further studies are needed to determine the means by which streptococcal pathogens affect host apoptotic pathways. Inhibition of the normal apoptotic pathways would allow for prolonged intracellular survival, which could facilitate dissemination and invasion into distant tissues.

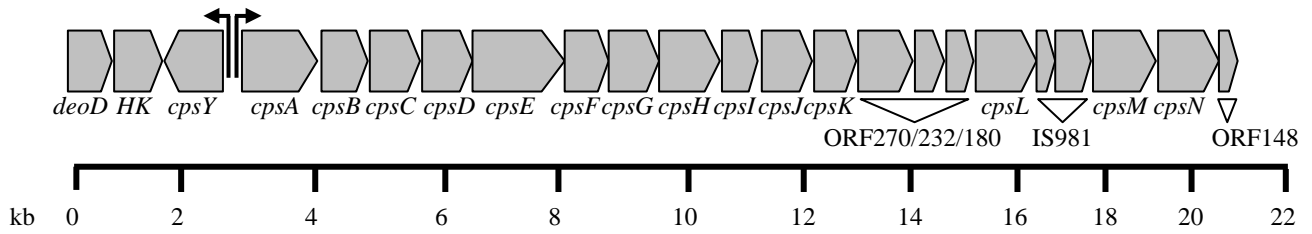
**Discovery of CpsY as a *S. iniae* virulence determinant.** Initial studies into the transcriptional regulation of the capsule operon of *S. iniae* revealed the presence of a second transcriptional regulator, CpsY, which is inversely oriented upstream of *cpsA* and the capsule operon, separated by a shared promoter region (Fig. 2) (185). CpsY was originally predicted to regulate capsule biosynthesis in *S. agalactiae* due to its adjacent location to the capsule operon (156). Transcriptional reporter constructs using either the *cpsY* or *cpsA* promoters controlling expression of the alkaline phosphatase gene

revealed significantly reduced expression from both the *cpsY* and *cpsA* promoters in a mutant with an in-frame-deletion of the *cpsY* gene ( $\Delta cpsY$ ), suggesting that CpsY transcriptionally activates both itself and the capsule operon (184). However, quantification of capsule biosynthesis by percoll gradient centrifugation showed that the  $\Delta cpsY$  mutant had only slightly decreased levels of capsule compared to wild type (185), indicating that CpsY has minimal effect on capsule biosynthesis. This was confirmed by quantitative PCR where no difference in expression of the capsule operon was observed in the  $\Delta cpsY$  mutant. Alkaline phosphatase promoter-reporter constructs for non-CpsY regulated promoters were also found to have low expression in the  $\Delta cpsY$  mutant (personal observations), suggesting that the observed dichotomy between qPCR, percoll gradient centrifugation and promoter-reporter results may be due to the inherent inability of the  $\Delta cpsY$  mutant to effectively express the alkaline phosphatase reporter, perhaps related to an uncharacterized toxicity of the gene product toward the  $\Delta cpsY$  mutant.

Infection of zebrafish by intramuscular injection of the  $\Delta cpsY$  mutant revealed a highly attenuated phenotype with minimal invasion to the brain and decreased systemic survival (185). Investigation into the regulation of *cpsY* showed that *cpsY*-promoter activity increased throughout logarithmic growth phase when cultured in Todd-Hewitt yeast broth (ThyB), but not when cultured in brain-heart infusion medium (BHI) (201). Immunohistochemistry of infected zebrafish revealed that expression from the *cpsY* promoter was rapidly shut off upon injection into the muscle tissue and remained off for the first 60 minutes post infection (p.i.); however, expression in the muscle tissue was observed by 24 hours (201). In contrast, expression from the *cpsY* promoter was observed as early as 15 minutes p.i. in the heart and 30 minutes p.i. in the spleen (201). Furthermore, at these early time points, expression appeared to occur only when the bacteria were localized intracellular in phagocytic cells. Overall the data suggest that CpsY is tightly regulated and may play a role in intracellular survival in vivo.

CpsY shares homology to the LysR family of transcriptional regulators (LTTR), which regulate





**Figure 2.** Capsule synthesis operon map of *S. iniae* (accession no. AY904444). Bent arrows indicate transcriptional promoter regions.

the expression of genes with a wide array of functions (254). CpsY is highly conserved among the streptococci, and homologs are found in both Gram positive and Gram negative species. CpsY orthologs in *Streptococcus mutans* and *S. agalactiae* have been renamed MetR and MtaR respectively due to their role in methionine transport and metabolism (259, 268), but evidence suggests that MtaR has significant regulatory function unrelated to methionine metabolic processes as well (42). The regulatory role CpsY has on methionine metabolic processes, as well as streptococcal virulence is the major focus of this work and will be comprehensively discussed in the following chapters.

## CHAPTER 2

**The *Streptococcus iniae* transcriptional regulator CpsY is required for protection from neutrophil-mediated killing and proper growth in vitro.**

**Abstract**

The ability of a pathogen to metabolically adapt to the local environment for optimal expression of virulence determinants is a continued area of research. Orthologs of the *Streptococcus iniae* LysR family regulator CpsY have been shown to regulate methionine biosynthesis and uptake pathways, but appear to influence expression of several virulence genes as well. A *S. iniae* mutant with an in-frame deletion of *cpsY* ( $\Delta cpsY$ ) is highly attenuated in a zebrafish infection model. The  $\Delta cpsY$  mutant displays a methionine-independent growth defect in serum, which differs from the methionine-dependent defect observed for orthologous mutants of *S. mutans* and *S. agalactiae*. On the contrary, the  $\Delta cpsY$  mutant can grow in excess of WT when supplemented with proteose peptone, suggesting an inability to properly regulate growth. CpsY is critical for protection of *S. iniae* from clearance by neutrophils in whole blood, but is dispensable for intracellular survival in macrophages. Susceptibility of the  $\Delta cpsY$  mutant to killing in whole blood is not due to a growth defect because inhibition of neutrophil phagocytosis rescues the mutant to WT levels. Thus CpsY appears to have a pleiotropic regulatory role for *S. iniae*, integrating metabolism and virulence. Furthermore *S. iniae* provides a unique model to investigate the paradigm of CpsY-dependent regulation during systemic streptococcal infection.

## Introduction

Our understanding of the diverse repertoire of transcriptional signaling networks that orchestrate optimal expression of virulence genes dependent upon the metabolic status of the cell is quickly expanding (265, 313). Metabolic adaptations to the various environments encountered by a pathogen within a host prove to be tremendously complex and under studied (87). Recent work on streptococcal pathogens has revealed components of these regulatory pathways that relate the nutritional status of the cell to control of growth phase and expression of virulence genes (3, 134, 145, 148, 192, 209, 272).

*S. iniae* is a major aquatic pathogen (88-89) that causes an invasive systemic infection with severe bacteremia culminating in meningoencephalitis (4). Many instances of zoonoses have been reported as a result of handling infected fish, typically resulting in a bacteremic cellulitis (95, 170, 305). The severity of an *S. iniae* infection is due in part to the ability to rapidly disseminate from the site of infection through the blood stream and invade systemic tissues (185). The complex pathogenicity of *S. iniae*, and other systemic streptococcal pathogens, is reflected in the diversity of genes that are critical to a successful infection (9, 142, 300). Several classical streptococcal virulence factors have been shown to be important for the virulence of *S. iniae*, including the SivS/R-regulated streptolysin S and CAMP factor (31, 181), as well as the major surface M protein (180). *S. iniae* also contains a polysaccharide capsule that functions for protection from phagocytic clearance in whole blood (182, 185, 202). Furthermore, several genes not previously studied for their virulence traits have been shown to have critical roles during *S. iniae* infection of hybrid striped bass (HSB), including phosphoglucomutase (*pgmA*) (45) and a novel polysaccharide deacetylase (*pdi*) (200).

We previously established the importance of a highly conserved LysR family transcriptional regulator, CpsY, in a zebrafish infection model (185). Deletion of *cpsY* ( $\Delta cpsY$ ) increased zebrafish survival by 40% 4 days post-infection. Moreover, the  $\Delta cpsY$  mutant displayed a unique inability to

disseminate to the brain within the first hour post-infection. CpsY was originally predicted to regulate capsule biosynthesis in *Streptococcus agalactiae* due to its adjacent location to the capsule operon (156). Further research determined that CpsY has little effect on capsule production in both *S. agalactiae* (259) and *S. iniae* (185). Rather, CpsY was renamed MtaR in *S. agalactiae* (259) and MetR in *S. mutans* (268) because of its influence on methionine biosynthesis and uptake. However, the regulatory function of MtaR in *S. agalactiae* appears to extend beyond methionine metabolism (42).

In the present study, we define a critical role for CpsY during *S. iniae* systemic infection. We show that CpsY is required for intracellular survival in neutrophils, but not macrophages, and that this is critical for bacterial survival in whole blood. Furthermore, we discuss variations in the CpsY-dependent regulation of methionine supply pathways that exist among streptococcal pathogens.

## Materials and Methods

**Bacterial strains, media and culture conditions.** *Streptococcus iniae* 9117 is a human clinical blood isolate from a patient with cellulitis (101). A mutant containing an in-frame deletion of the *cpsY* gene used in this work was constructed previously (185). Streptococcal strains were routinely cultured in Todd-Hewitt broth (BBL) supplemented with 0.2% yeast extract (BBL) (THY) in conical tubes without shaking at 37 °C. For bacterial enumeration, serial dilutions were plated on THY agar plates and incubated at 37 °C in 5% CO<sub>2</sub>. In all assays, overnight bacterial cultures were diluted 1:50 in fresh medium, and grown to mid-exponential phase (OD<sub>600</sub> 0.225) unless otherwise stated.

**Bacterial growth curves.** Overnight bacterial cultures were diluted 1:50 in 96-well plates containing a 200 µl total volume of THY or C medium (189), supplemented with either 400 µg ml<sup>-1</sup> L-methionine (Sigma) or 2% proteose peptone #3 (BBL) when required. The plates were incubated at 37 °C in 5% CO<sub>2</sub>, and OD<sub>600</sub> values were measured every 30 min using a Versamax<sup>TM</sup> microplate reader (Molecular Devices).

Growth assays in human serum were performed as previously described for *Streptococcus agalactiae* (259). Briefly, non-heparinized blood was obtained from human volunteers by venipuncture, allowed to clot and centrifuged at 1000 x g for 5 min. Mid-exponential phase cultures of *S. iniae* strains grown in THY were collected by centrifugation, washed 2 times in phosphate buffered saline (PBS, Invitrogen) and diluted to 1 x 10<sup>5</sup> CFU ml<sup>-1</sup> in PBS. Ten microliters of diluted bacteria was added to 1 ml of DMEM with 50% human serum in a 1.5 ml microcentrifuge tube, supplemented with 400 µg ml<sup>-1</sup> L-methionine (Sigma) when required. Tubes were incubated at 37 °C with gentle rotation. At the indicated time points, bacterial growth was determined by serial dilution on THY agar.

**Zebrafish infections.** Groups of 6 zebrafish (*Danio rerio*) adults were infected by intramuscular (i.m.) injection into the dorsal muscle with either *S. iniae* WT or the  $\Delta cpsY$  mutant from mid-exponential phase cultures as previously described (215). A 30-gauge needle was used to inject

10  $\mu\text{l}$  of a  $1 \times 10^7$  CFU  $\text{ml}^{-1}$  bacterial suspension in PBS for an infectious dose of  $1 \times 10^5$  CFU. Zebrafish were euthanized with a lethal dose of Ethyl 3-aminobenzoate methanesulfonate (Tricaine, Sigma) at the indicated time point, and specific organs were harvested and gently homogenized in 300  $\mu\text{l}$  PBS. One hundred microliters of the homogenate was loaded into a cytology funnel (Thermo), centrifuged onto glass slides for 3 min at 700 rpm in a Cytospin 1 centrifuge (Shandon Elliott) and stained using the HEMA 3 stain set (Fisher Scientific). Slides were viewed and documented with an Axioskop 40 microscope (Carl Zeiss, Inc.) fitted with an AxioCam MRc camera.

**RNA isolation and quantitative polymerase chain reaction (qPCR).** Bacteria were subcultured to logarithmic phase or early stationary phase in either THY or THY supplemented with 2% proteose peptone #3 (TP). When required, 4 mM L-methionine (Sigma) or homocysteine (Sigma) was added for 30 min upon reaching the appropriate growth phase. Five milliliters of culture was centrifuged and resuspended in 1 ml phosphate buffered saline (PBS) with 25  $\text{mg ml}^{-1}$  lysozyme (Sigma) and 50 U of mutanolysin (Sigma). Following 30 min incubation at 37 °C, the bacteria were centrifuged, resuspended in 1 ml Trizol (Sigma) and incubated at room temperature for 5 min. Two hundred microliters of chloroform was added to the suspensions, mixed vigorously and incubated an additional 3 min at room temperature. The preparations were centrifuged 13,000  $\times g$  at 4 °C for 15 min. The aqueous phase was transferred to a fresh microcentrifuge tube, mixed with 500  $\mu\text{l}$  isopropanol and incubated 10 min at room temperature. The samples were centrifuged 13,000  $\times g$  at 4 °C for 15 min, washed twice with 70% ethanol, and resuspended in 100  $\mu\text{l}$  of water. Contaminating DNA was digested with 5  $\mu\text{g}$  of DNaseI (Qiagen) at 37 °C for 2 hrs, and RNA was purified using the RNeasy® MinElute™ cleanup kit (Qiagen). For isolation of macrophage RNA, infected or mock-treated cells were washed twice in PBS, and RNA was collected using the SV total RNA isolation kit (Promega) per manufacturer instructions.

For qPCR reactions 100 µg of total RNA was combined in 20 µl total reaction volumes with 0.2 µM forward and reverse primers, Express SYBR® GreenER™ (Invitrogen) and Express SuperScript® Mix (Invitrogen) per manufacturer instructions. Primer sequences for transcriptional analysis of *S. iniae* were as follows: *recA* fwd 5'-CTCAGGTGCTGTTGATTTGG-3', *recA* rev 5'-TGCAGAGAGTTTACGCATGG-3'; *atmB* fwd 5'-CCCGTTGGGATAAAATTGAA-3', *atmB* rev 5'-CACCATTTGCAACTGCCTTA-3'. Primer sequences for transcriptional analysis of infected macrophages were as follows: β-actin fwd 5'-TAAAACGCAGCTCAGTAACAGTCCG-3', β-actin rev 5'-TGGAATCCTGTGGCATCCATGAAAC-3'; FLIP fwd 5'-CGTCTCCTGCCTTGCTTCAG-3', FLIP rev 5'-CGAACCCAGACACTGCACAA-3'; XIAP fwd 5'-CTGAGTATATCCATGTCC-3', XIAP rev 5'-ATGCAGAATGGTCAGTAC-3'; BclXL fwd 5'-TTCGGGATGGAGTAAACTGG-3', BclXL rev 5'-TGCAATCCGACTCACCAATA-3'; Bax fwd 5'-CCCCAGTTGAAGTTGCCATC-3', Bax rev 5'-GTTTCATCCAGGATCGAGCAG-3'. Reactions were performed in triplicate using a BioRad iCycler™ with the following cycling conditions: 5 min at 50 °C, 2 min at 95 °C, 40 cycles of 15 sec 95 °C and 1 min 60 °C. Melting curves were performed after completion of each experiment. Relative fold change in gene expression was calculated by  $2^{-(\Delta\Delta C_T)}$ , where  $\Delta\Delta C_T$  is  $[C_T(\text{target gene}) - C_T(\text{recA})]_{\text{mutant}} - [C_T(\text{target gene}) - C_T(\text{recA})]_{\text{wild type}}$ ,  $C_T$  being the threshold cycle.

**Sequence alignment.** *S. iniae* genomic sequence data was obtained from Human Genome Sequencing Center at Baylor College of Medicine. Sequences for the CpsY orthologs MtaR of *S. agalactiae* A909 (YP\_329877), MetR of *S. mutans* UA159 (AAN58910), CpsY of *S. pyogenes* (NP\_269094) and CpsY of *S. iniae* (AAY17292), as well as the nucleotide promoter sequence immediately upstream of *atmB* (*metQ1*) of *S. agalactiae* A909 (YP\_330257), *S. mutans* UA159 (AAN59551) and *S. pyogenes* (NP\_268657) were obtained from GenBank. Sequences were aligned and plotted using ClustalX through the Mobyly portal (<http://mobyly.pasteur.fr/cgi-bin/portal.py>) (216).



**Macrophage adherence, internalization and survival assays.** The RAW 264.7 murine macrophage cell line (242) was maintained in 75 cm<sup>2</sup> cell culture flasks (Corning) in Dulbecco's Modified Eagle's Medium (DMEM; Gibco) containing 10% heat-inactivated fetal bovine serum (FBS; Gibco) at 37 °C with 5% CO<sub>2</sub>. Macrophage infection assays were performed in 24 well flat bottom plates (Greiner bio-one). One day prior to each assay, macrophages were seeded at a density of 0.5 x 10<sup>6</sup> cells per well in 1 ml DMEM with 10% FBS medium. When required, macrophages were activated with 100 U ml<sup>-1</sup> of murine IFN- $\gamma$  at 1.5 hr post-seeding. After overnight incubation, cell culture medium was removed and macrophages were washed 3 times with PBS. Mid-exponential phase bacteria were diluted 1:100 into 1 ml DMEM with 10% FBS medium, which was then added to cells at an MOI of 1 (bacteria:cells). The plates were centrifuged for 5 min at 250 x g to allow for contact between bacteria and the cell monolayer. After 1 hr, cell culture medium was removed, and macrophages were washed 5 times with 1 ml of PBS for removal of any non-adherent bacteria. For adherence assays, the cells were lysed in 1 ml sterile ddH<sub>2</sub>O and 100  $\mu$ l was serially diluted and plated on THY agar for enumeration of bacterial CFU, which represents both adhered and internalized bacteria. For internalization and survival assays, infected cells were incubated with 1 ml fresh DMEM with 10% FBS containing 100  $\mu$ g ml<sup>-1</sup> gentamicin (Gibco) for 1 hr to kill all extracellular bacteria. After the 1 hour incubation, cells were washed 3 times with PBS. For internalization assays, cells were lysed in 1 ml sterile ddH<sub>2</sub>O and 100  $\mu$ l was removed, serially diluted and plated on TP agar for enumeration of surviving intracellular bacteria. For survival assays, 1 ml of fresh DMEM with 10% FBS was added, which was then considered to be the 0 hr time point. At specified times supernatants were collected, cells were washed 3 times in PBS and lysed in 1 ml sterile ddH<sub>2</sub>O. One hundred microliters of supernatants and lysates were serially diluted and plated on THY agar for enumeration of bacterial CFU. Final adherence numbers were calculated by (adhered: internalized CFU) –

(internalized CFU). All infections were performed in duplicate and each experiment was repeated 3 times.

**Fluorescent microscopy for macrophage viability.** To assess cell viability, macrophage infections were carried out as described above except circular glass coverslips were placed in each well prior to macrophage seeding. At specified time points, culture medium was removed and cells were gently washed 3 times in 1 ml sterile 0.9% NaCl. The LIVE/DEAD<sup>®</sup> *BacLight*<sup>™</sup> kit (Invitrogen) was used to visualize cell viability per manufacturer's instructions. Briefly, 1 ml of 0.9% saline with 3  $\mu$ l of an equal mixture of SYTO 9 dye and propidium iodide was added to the cells in the 24 well plate, and incubated at room temperature in the dark for 15 minutes. The coverslips were then carefully removed from the wells and gently placed cell side up onto glass microscope slides, immersed in *BacLight*<sup>™</sup> mounting oil, and covered with a final glass coverslip. Prepared slides were photographed by fluorescence microscopy using an Axioskop 40 microscope (Carl Zeiss, Inc.) fitted with an AxioCam MRc camera.

**Macrophage apoptosis assay.** Macrophages were infected as above with either live bacteria or culture supernatants collected from growth during mid-logarithmic phase. Culture supernatants were filtered through an 0.2 micrometer filter, and either fractioned using a 50 kDa or 100 kDa cutoff centrifugal filter unit (Amicon) or treated with 1 mg ml<sup>-1</sup> proteinase K (Sigma) in 10 mM Tris Hcl, pH 7.5 buffer for 2 hr at 37 °C when required. At 21 hr post-infection, 0.3  $\mu$ M staurosporine (Sigma) or 1  $\mu$ M camptothecin (Sigma) was added for 3 hr to induce apoptosis. At 24 hr post-infection induction of apoptosis was determined by measuring caspase 3 activity using the EnzChek Caspase 3 Assay Kit # 2 (Invitrogen/Molecular Probes) per manufacturer instructions.

**Whole blood survival.** Heparinized human whole blood was collected by venipuncture. When required, cytochalasin D (Sigma) was added to a final concentration of 10  $\mu$ g ml<sup>-1</sup> 30 min. prior to incubation with bacteria. Mid-exponential phase bacterial cultures were adjusted to 1 x 10<sup>4</sup> CFU ml<sup>-1</sup>

<sup>1</sup>, inoculated 1:100 in 1 ml whole blood, and incubated for 3 hours at 37 °C with gentle rotation. One hundred microliters was serially diluted and plated on THY agar for enumeration of bacterial survival. All infections were performed in duplicate and each experiment was repeated 3 times.

**Neutrophil infections.** Human polymorphonuclear leukocytes, or neutrophils, were isolated as follows. Heparinized human whole blood was collected by venipuncture and mixed in equal volume with 3% dextran (MP Biomedicals) in saline using 50 ml conical tubes. Red blood cells were allowed to sediment out and the supernatant was centrifuged for 10 min at 800 x g at 4 °C to pellet the remaining cellular fraction. Pellets were resuspended in 35 ml 0.9% NaCl and a 10 ml underlay of Ficoll-Paque (GE Healthcare) was applied. This was centrifuged for 30 min at 410 x g in a hanging bucket rotor at room temperature to separate out the granulocyte fraction. The supernatant was gently aspirated down to the loose pellet of granulocytes and erythrocytes. Remaining erythrocytes were lysed by resuspension of the pellet with 10 ml sterile H<sub>2</sub>O for 28 seconds and isotonicity was quickly restored with 10 ml 1.8% NaCl. Purified neutrophils were pelleted by centrifugation at 500 x g and resuspended in 3 ml DMEM. Neutrophil concentration was determined by hemocytometer count.

For infections, neutrophils were diluted to a final concentration of  $1 \times 10^6$  cells ml<sup>-1</sup> in DMEM with 50% human serum. When required, neutrophils were pretreated 30 min prior to addition of bacteria with 10 µg ml<sup>-1</sup> cytochalasin D (Sigma) at 37 °C with gentle rotation. For experiments requiring heat-inactivated serum, human serum samples were incubated at 55 °C for 30 min prior to neutrophil addition. Mid-exponential phase cultures were washed twice in PBS and diluted to  $1 \times 10^5$  CFU ml<sup>-1</sup> in PBS. Ten microliters was inoculated into a 1 ml neutrophil suspension or media alone using 1.5 ml microcentrifuge tubes. Samples were incubated at 37 °C for 3 hr with gentle rotation. One hundred microliters of the sample was serially diluted and plated on THY agar for enumeration of bacterial survival. In parallel, 100 µl of the same sample was loaded into a cytology funnel (Thermo), centrifuged onto glass slides for 3 min at 700 rpm in a Cytospin 1 centrifuge (Shandon Elliott) and

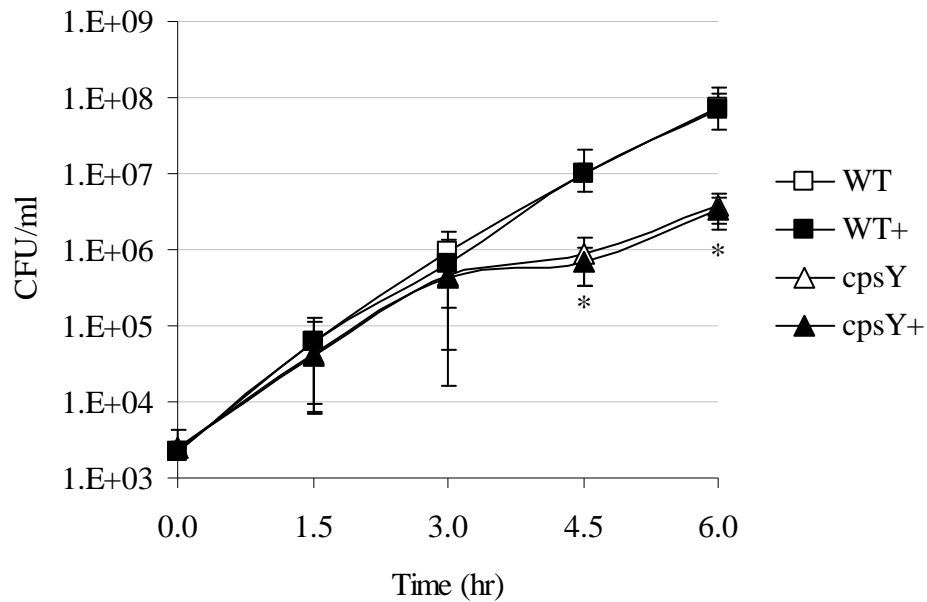
stained using the HEMA 3 stain set (Fisher Scientific). Slides were viewed with an Axioskop 40 microscope (Carl Zeiss, Inc.) fitted with an AxioCam MRc camera.

**Statistical analysis.** A statistical analysis for all functional tests was performed by two-tailed Student's  $t$  test using StatView analysis software.

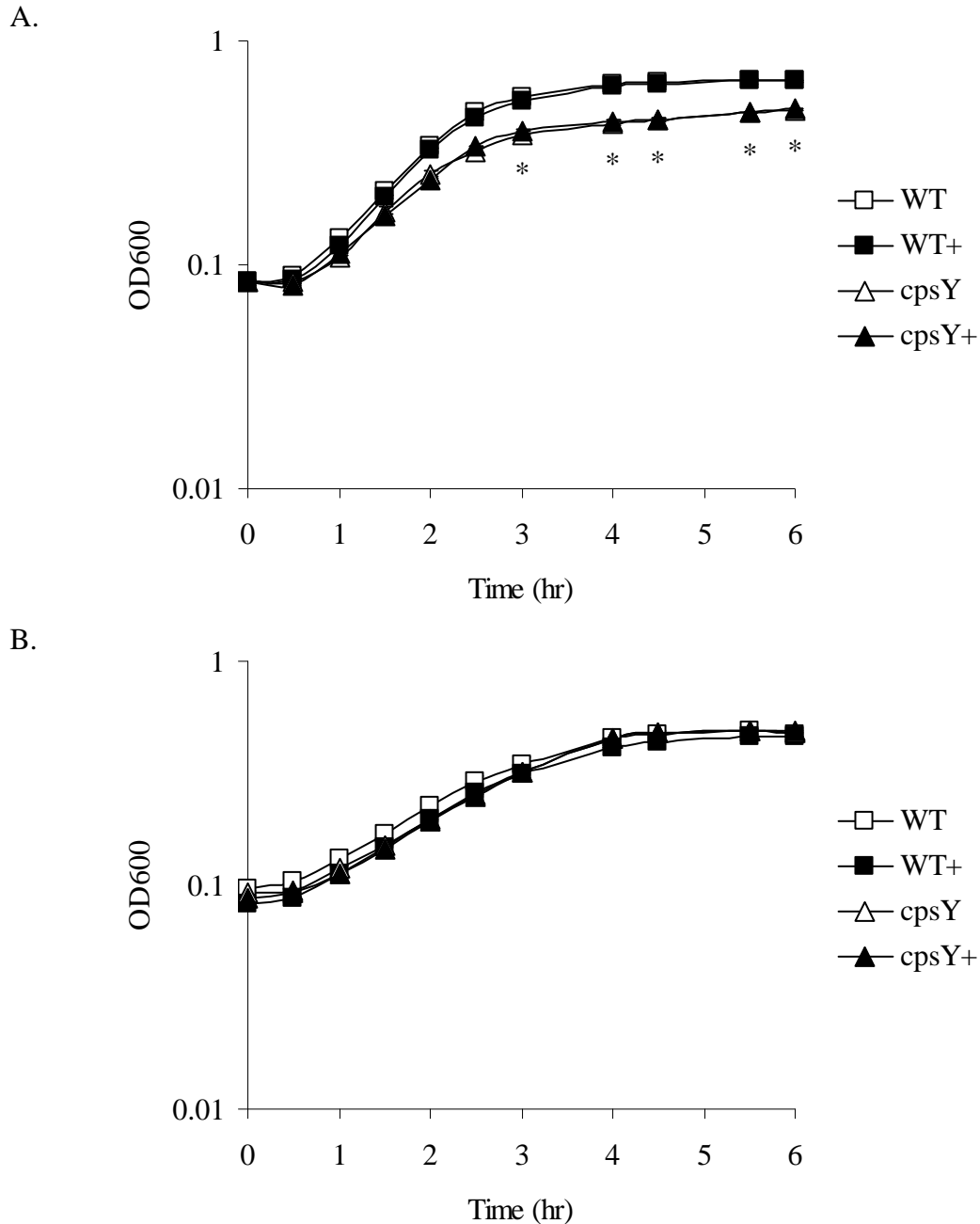
## Results

**CpsY influences growth in vitro.** Previous work demonstrated that disruption of the CpsY ortholog MtaR in *S. agalactiae* results in a significant growth defect in human plasma that can be rescued with excess methionine (42, 259). To determine if this same phenotype existed in *S. iniae*, both the WT and the  $\Delta cpsY$  mutant were cultured in human serum supplemented with and without 400  $\mu\text{g ml}^{-1}$  L-methionine. Growth of the  $\Delta cpsY$  mutant paralleled that of WT for the first 3 hours in serum alone, after which a significant drop in the growth rate resulted in approximately 1.5 log fewer CFU  $\text{ml}^{-1}$  recovered by 6 hr (Fig 3). This attenuation could not be rescued with excess methionine. The additional methionine had no influence on the growth of WT *S. iniae* consistent with previous reports for *S. agalactiae* (259).

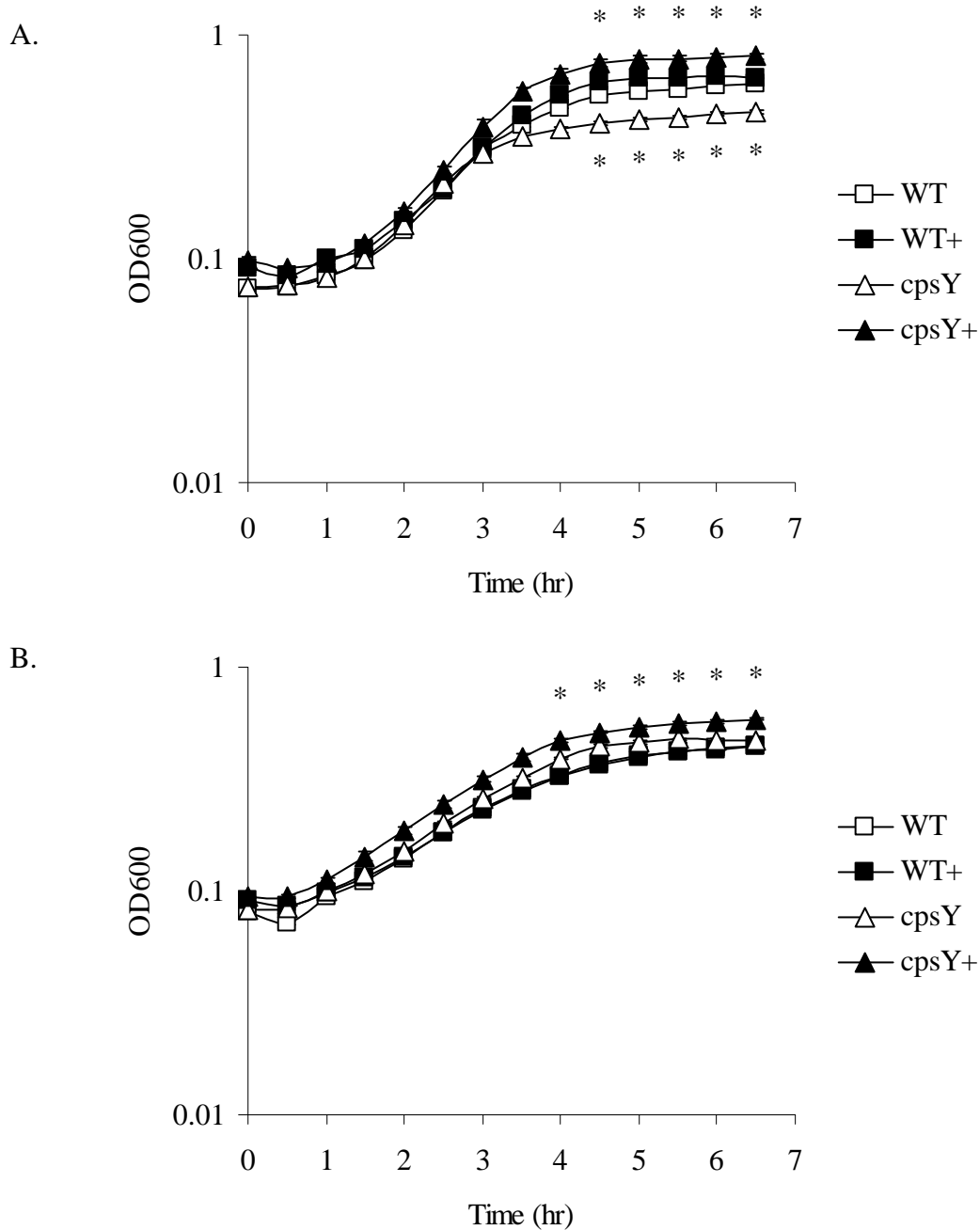
To determine whether this same methionine-independent growth attenuation of the  $\Delta cpsY$  mutant translated to other media, growth was examined in THY both, a complex medium containing neopeptone, beef heart infusion, yeast extract and dextrose as a carbon source. In this medium, the  $\Delta cpsY$  mutant exhibited a similar pattern to growth in serum, demonstrating a significant drop after 3 hrs, which was independent of methionine (Fig. 4A). However when cultured in C-medium, a medium containing yeast extract and 0.5% proteose peptone 3 but no dextrose, the  $\Delta cpsY$  mutant grew identical to WT (Fig. 4B). This identical growth pattern was due to a decrease in cell density at stationary phase of the WT in C-medium compared to THY, and not due to an enhancement in the growth of the  $\Delta cpsY$  mutant. Again, the addition of excess methionine had no effect on growth of either WT or the  $\Delta cpsY$  mutant. Because C-medium contains proteose peptone 3, we supplemented THY broth with 2% proteose peptone #3 and monitored growth of WT and the  $\Delta cpsY$  mutant. Adding peptone drastically extended exponential growth of the  $\Delta cpsY$  mutant reaching a final cell density over 2.5 times greater than without peptone (Fig 5A). This was contrasted by the minimal change in growth observed for WT *S. iniae* in the presence of peptone (Fig. 5A). A similar trend was observed for growth of the two



**Figure 3.** Serum growth curves. Mid logarithmic phase cultures of *S. iniae* WT along with the  $\Delta cpsY$  mutant were diluted into 1 ml DMEM 50% human serum with (+) or without 400  $\mu\text{g ml}^{-1}$  L-methionine. Samples were incubated at 37 °C and bacterial CFU were determined at the indicated time points by serial dilution and plating on THY. Error bars represent  $\pm$  standard error. \* $p < 0.05$  compared to WT.



**Figure 4.** Effect of methionine on bacterial growth. Overnight cultures of *S. iniae* WT and the  $\Delta cpsY$  mutant were diluted 1:50 into 200  $\mu$ l of THY (A) or C-medium (B). When required, medium was supplemented with 400  $\mu$ g ml<sup>-1</sup> L-methionine (+). Samples were incubated at 37 °C and OD<sub>600</sub> measurements were recorded every 30 min. A representative experiment is shown. Error bars represent  $\pm$  standard error. \* $p < 0.05$  compared to WT.



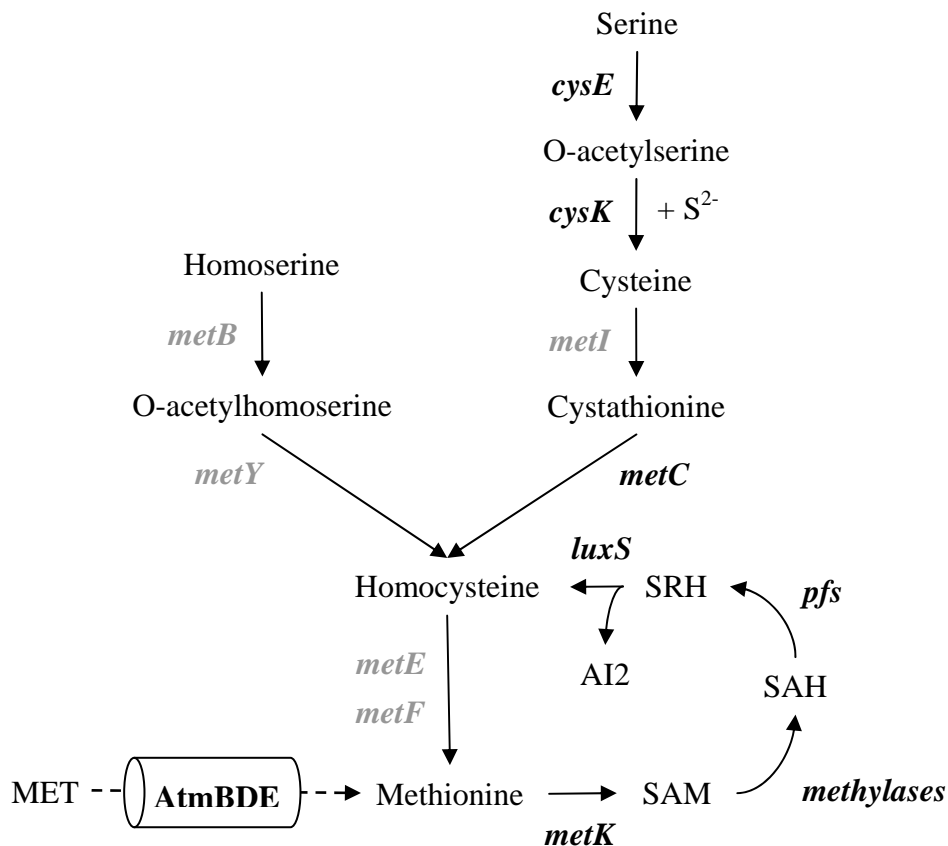
**Figure 5.** Effect of proteose peptone on bacterial growth. Overnight cultures of *S. iniae* 9117 WT and the  $\Delta cpsY$  mutant were diluted 1:50 into 200  $\mu$ l of THY (A) or C-medium (B). When required, the medium was supplemented with 2% proteose peptone #3 (+). Samples were incubated at 37 °C and OD<sub>600</sub> measurements were recorded every 30 min. A representative experiment is shown. Error bars represent  $\pm$  standard error. \* $p < 0.05$  compared to WT.



strains in C-medium although growth phenotypes were not as severe (Fig. 5B). This suggests that WT *S. iniae* can manage the excess nutrients supplied in peptone with minimal effect on normal growth patterns, whereas the  $\Delta cpsY$  mutant displays a type of unrestrained exponential growth. Overall the data indicate that CpsY influences the growth patterns of *S. iniae* in a methionine-independent manner.

**CpsY regulation of methionine metabolic pathways.** The *S. iniae* CpsY protein shares 79% amino acid sequence identity to the orthologs MtaR of *S. agalactiae* and MetR of *S. mutans*. Both MtaR and MetR have been shown to regulate genes involved in methionine biosynthesis and uptake (259, 268). Thus we hypothesized that the insensitivity to methionine on growth of the  $\Delta cpsY$  mutant may be due to differences in these metabolic pathways. To address this hypothesis the genomes of *S. iniae* and several other streptococcal species were examined by BLAST analysis for the presence of genes involved in the biosynthesis and uptake of methionine as previously described for *S. mutans* (Fig. 6) (268). Neither *S. iniae* nor *S. agalactiae* possess the full complement of genes required for de-novo methionine biosynthesis from cysteine (Table 1); however, all streptococcal species investigated were found to contain the AtmBDE (MetQ1NP) methionine transport system. Additionally, *S. agalactiae* contains the genes encoding MetE and MetF for conversion of homocysteine to methionine. *S. iniae* does not possess *metE* or *metF*, and thus appears to be purely auxotrophic for methionine.

The methionine-dependent growth defect of the *S. agalactiae* *mtaR* mutant was attributed to the inability to effectively transport exogenous methionine due to reduced expression of the MetQ1NP methionine transport system (42, 259). Although exogenous methionine could not rescue growth of the *S. iniae*  $\Delta cpsY$  mutant (Fig. 4), the role of CpsY in regulation of the AtmBDE locus was still in question. Quantitative PCR (qPCR) was performed to assess CpsY-dependent regulation of the *atmB* gene under various growth conditions. When cultured in THY broth to either mid-logarithmic or stationary phase, there was < 2 fold change in gene expression for the  $\Delta cpsY$  mutant relative to WT



**Figure 6.** Schematic of streptococcal methionine biosynthesis and uptake pathways. The pathways represented were previously characterized for *S. mutans* (50). Genes present in *S. iniae* as determined by BLASTP analysis are shown in black, while genes absent are in grey. Gene designations are listed in Table 1. SAM, S-adenosylmethionine; SAH, S-adenosylhomocysteine; SRH, S-ribosylhomocysteine; MET, Methionine; AI2, Autoinducer 2.

**Table 1.** Orthologs of the methionine metabolism and transport pathways.

Gene	Function	<i>Sin</i> <sup>a</sup>	<i>Spy</i> <sup>a</sup>	<i>Sag</i> <sup>a</sup>	<i>Smu</i> <sup>a</sup>
<i>cysE</i>	Serine acetyltransferase	+	+	+	+
<i>cysK</i>	Cysteine synthase	+	+	+	+
<i>metI</i>	Cystathionine $\gamma$ -synthase	0	0	0	+
<i>metC</i>	Cystathionine $\beta$ -lyase	+	+	+	+
<i>metB</i>	Homoserine <i>O</i> -succinyltransferase	0	0	0	+
<i>metY</i>	<i>O</i> -acetylhomoserine sulfhydrylase	0	0	0	+
<i>metE</i>	Methionine synthase	0	0	+	+
<i>metF</i>	5,10-methylenetetrahydrofolate reductase	0	0	+	+
<i>metK</i>	<i>S</i> -adenosylmethionene synthase	+	+	+	+
<i>pfs</i>	Methylthioadenosine nucleosidase	+	+	+	+
<i>luxS</i>	<i>S</i> -ribosylhomocysteinase	+	+	+	+
<i>atmB</i>	ABC transporter, Substrate binding protein	+	+	+	+
<i>atmD</i>	ABC transporter, ATP binding protein	+	+	+	+
<i>atmE</i>	ABC transporter, Permease	+	+	+	+

<sup>a</sup> Species designations are as follows: *Sin*, *Streptococcus iniae* 9117; *Spy*, *Streptococcus pyogenes* M1 GAS; *Sag*, *Streptococcus agalactiae* A909; *Smu*, *Streptococcus mutans* UA159. Symbol designations are (+) for the presence or (0) for absence of the gene as determined by BLASTP using genes previously identified in *S. mutans*.

**Table 2.** Relative *atmB* expression for  $\Delta cpsY$ 

Media <sup>a</sup>	Growth Phase	<i>atmB<sub>N</sub></i> relative to WT <sup>b</sup>
THY	mid logarithmic	0.585 ± 0.17
THY	stationary	1.154 ± 0.14
THY + MET	mid logarithmic	0.349 ± 0.03
THY + HC	mid logarithmic	1.302 ± 0.03
THY + MET	stationary	0.288 ± 0.05
THY + HC	stationary	0.857 ± 0.04
TP	mid logarithmic	2.607 ± 0.49
TP	stationary	1.280 ± 0.53

<sup>a</sup>Addition of 4 mM L-methionine (MET) or homocysteine (HC) for 30 min.

<sup>b</sup>Relative fold change (N) as determined by the  $\Delta\Delta CT$  method.

(Table 2). However, addition of 4 mM exogenous methionine for 30 min at mid-logarithmic or stationary phase resulted in a relative decreased expression of over 2.5 and 3.5 fold respectively. This suggests that CpsY is a transcriptional activator of *atmB* in the presence of methionine. Addition of exogenous homocysteine, however, had minimal effect on *atmB* gene expression. In contrast to these observations, addition of 2% proteose peptone (TP) resulted in 2.5 fold increased expression of *atmB* relative to WT during mid-log phase, but not stationary phase. Thus CpsY functions as a transcriptional activator of *atmB* in the presence of exogenous methionine; however, the presence of proteose peptone disrupts this regulation, suggesting other regulatory elements may be involved.

Transcriptional control of *atmB* by CpsY orthologs is proposed to occur through interactions with a specific promoter element termed the Met box (42, 248, 268). Sequence alignment of the *atmB* promoter region in *S. iniae* to several other streptococcal species revealed the presence of a Met box in the same position upstream of the predicted -10, -35 sites (Fig. 7). Overall the data are concurrent with the proposed regulation of the AtmBDE methionine transporter for other streptococcal species. However, this regulation does not explain how CpsY influences *S. iniae* growth given that exogenous methionine does not rescue the  $\Delta cpsY$  mutant in vitro. Thus, CpsY may have pleiotropic effects on *S. iniae* that extend beyond regulation of methionine metabolism, which has also been suggested for *S. agalactiae* (42).

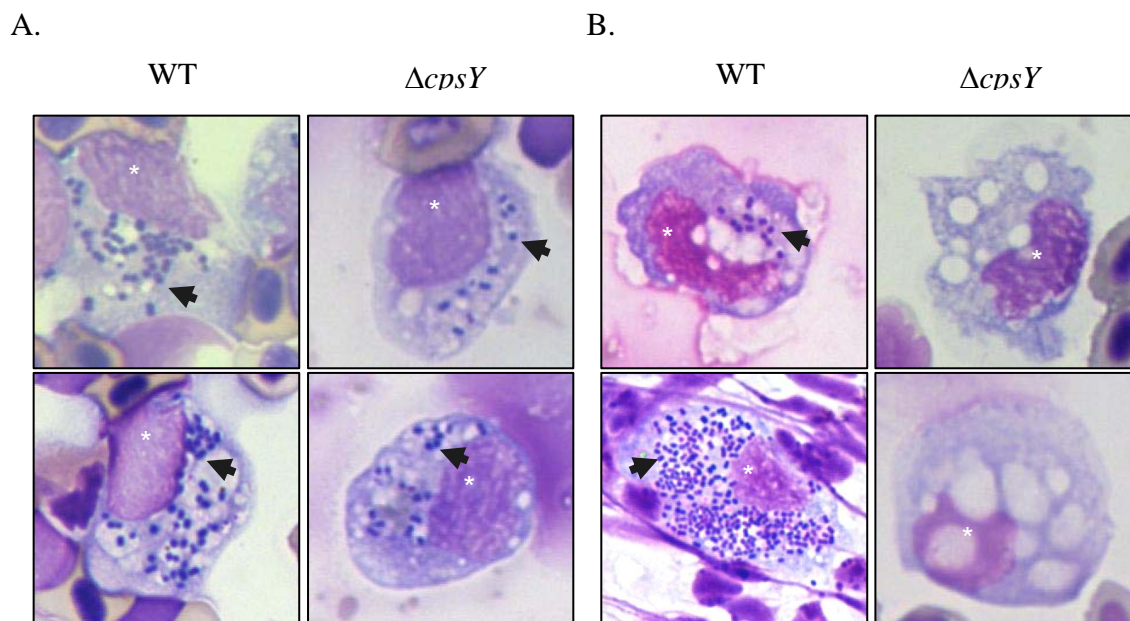
**CpsY facilitates *S. iniae* tissue specific localization within macrophages.** During previous studies of *S. iniae*, CpsY was found to be essential for systemic infection in a zebrafish model (185). Whereas wild type (WT) *S. iniae* could disseminate rapidly to the brain following intramuscular injection, the  $\Delta cpsY$  mutant displayed an inability to efficiently spread beyond the spleen (185). Thus, we sought to determine a more specific function for CpsY during the course of systemic infection. Adult zebrafish were infected with WT *S. iniae* or the  $\Delta cpsY$  mutant by intramuscular injection, and systemic organs were harvested 24 hr post-infection for histological analysis. Visual examination of

```

Sag -TATAGTTTAAAACTATA-N22-TTGATT-N16-GATAAT-N8-C-N22-ATG
Spy -TATAGTTTAAAACTATG-N22-TTGAAA-N17-TACAAT-N6-C-N28-ATG
Sin -TATAGTTTAAAACTATA-N22-TTGATA-N17-TAGAAT-N5-C-N24-ATG
Smu -TATAGTTTTTTAGCTATA-N22-TTGATA-N16-GAGAAT-N7-C-N24-ATG
      →   Metbox   ←           -35           -10

```

**Figure 7.** Promoter alignment for the *atmBDE* cluster. Sequences obtained from GenBank were aligned and plotted using ClustalX. The previously determined *S. mutans* transcriptional start site (50) is in bold, predicted -10 and -35 sites are underlined, translational start codon is italicized, and predicted Met boxes are shaded. Sag, *S. agalactiae* A909; Spy, *S. pyogenes* M1; Sin, *S. iniae* 9117; Smu, *S. mutans* UA159.



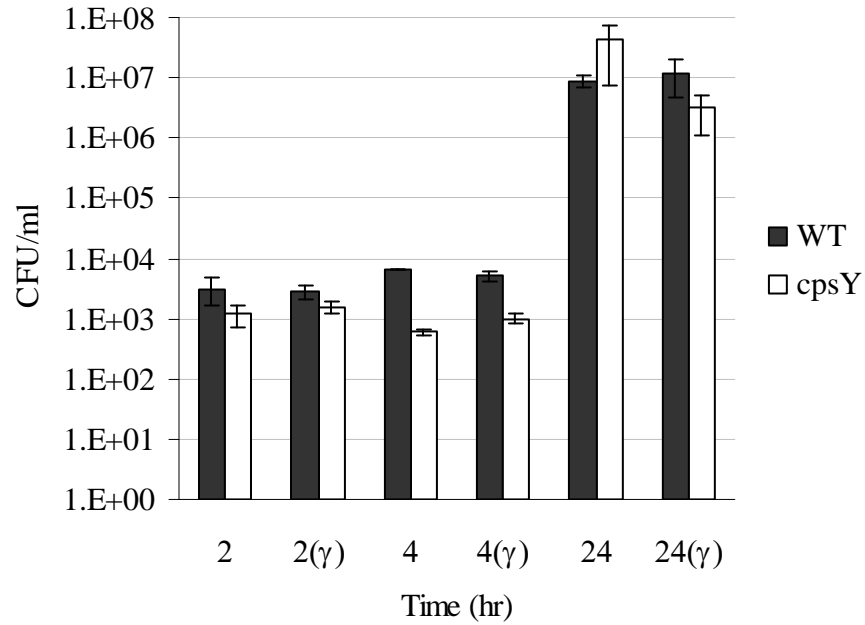
**Figure 8.** Images of tissue homogenates from *S. iniae*-infected zebrafish. Zebrafish were injected i.m. with  $10^5$  CFU of either *S. iniae* WT or the  $\Delta cpsY$  mutant. Zebrafish spleens (A) or brains (B) were dissected 24 hours post-infection, gently homogenized in PBS, cytocentrifuged on to glass slides and stained for visualization. Two representative images for each condition are shown. Black arrows depict examples of intracellular bacteria within macrophages. Macrophage nuclei are noted with a white asterisk.

HEMA-stained cytospin preparations from spleen homogenates showed that both WT and the  $\Delta cpsY$  mutant were contained within macrophage phagosomal compartments (Fig. 8A). For all infected fish ( $n = 6$ ), the majority of splenic macrophages were filled with cocci with few extracellular bacteria observed. In contrast, only WT could be detected in cytospin preparations of brain homogenates (Fig. 8B). Brain macrophage-like cells from  $\Delta cpsY$ -infected fish showed signs of activation with large empty phagosomal vacuoles, but contained no bacteria (Fig. 8B). These results suggest that *S. iniae* localizes within tissue macrophages during the course of systemic infection, and that CpsY affects this localization within specific tissue environments.

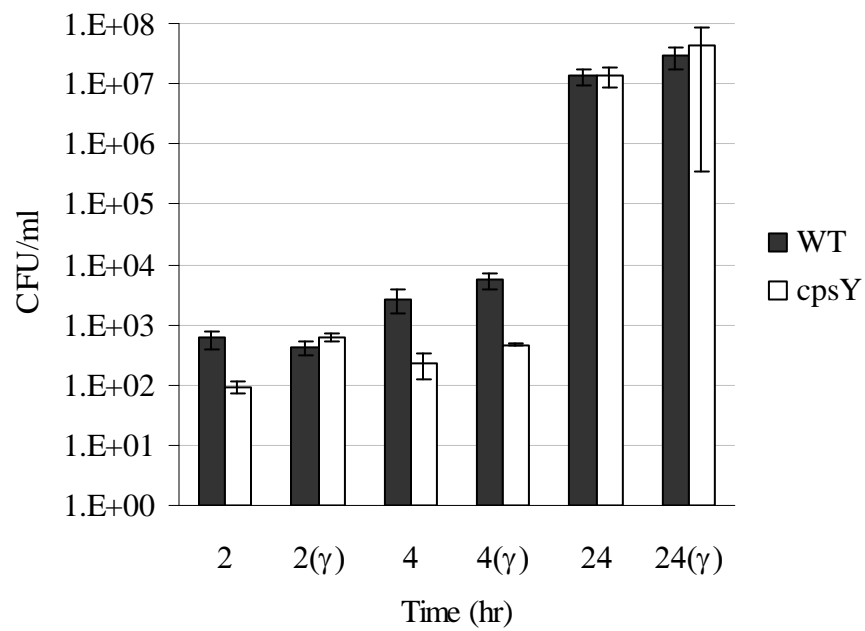
**Intracellular survival in macrophages is independent of CpsY.** Because of the tissue specific macrophage localization observed in the zebrafish infection model, we sought to determine if *S. iniae* intracellular survival in macrophages was dependent upon CpsY. The RAW 264.7 murine macrophage cell line (242) was used as an in vitro platform to evaluate streptococcal-macrophage interactions. Macrophages were infected with either WT *S. iniae* or the  $\Delta cpsY$  mutant for 1 hr to allow for bacterial uptake, followed by a 1 hr gentamicin treatment to kill all extracellular bacteria. Bacterial growth was then determined at various time points over the following 24 hrs. No significant difference was observed between *S. iniae* WT and the  $\Delta cpsY$  mutant in macrophage cell lysates (Fig. 9A) or culture supernatants (Fig. 9B) at all time points tested. The number of bacteria remained relatively constant at the 2 and 4 hour time points, and by 24 hr had increased over 3-logarithms. Adherence and internalization assays also revealed no significant difference in bacterial uptake by macrophages (Fig. 9C). Furthermore, macrophage activation by pretreatment with IFN- $\gamma$  resulted in no significant difference from untreated samples (Fig. 9). *S. iniae* does not appear to be actively killing macrophages because viability staining of infected macrophages showed the majority of macrophages to be alive, intact and filled with bacteria through 48 hr (Fig. 10). Overall these results indicate that CpsY does not



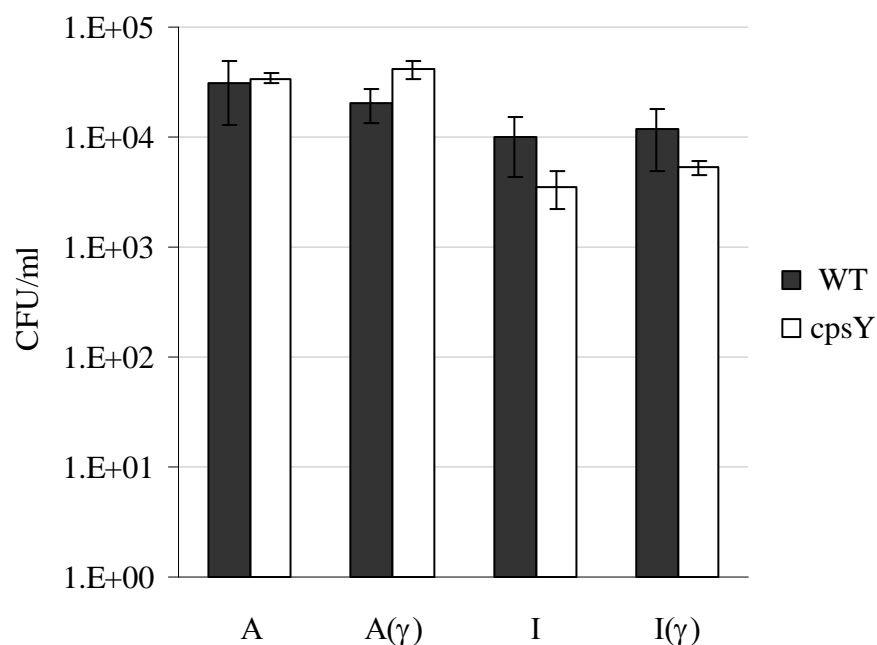
A.



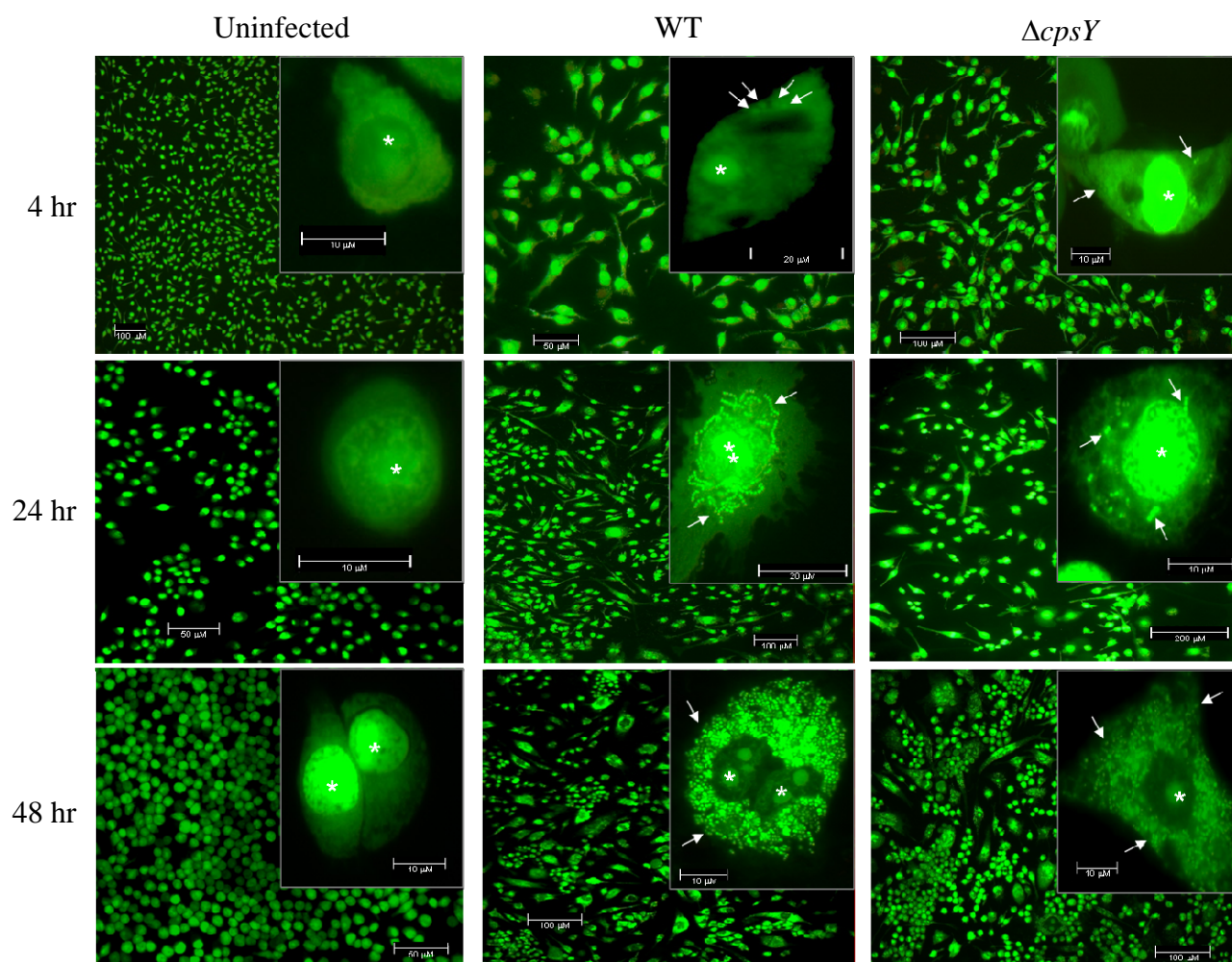
B.



C.



**Figure 9.** *S. iniae* macrophage infections. Raw 264.7 macrophages were infected at an M.O.I. of 1 with WT (grey bars) or  $\Delta cpsY$  (white bars) as described in materials and methods. At required time points culture supernatants were collected, cells were washed, and lysed in H<sub>2</sub>O. Dilutions of the cell lysates (A) and culture supernatants (B) were serially diluted and plated for bacterial CFU. For certain experiments, macrophages were activated by pretreatment with 100 U ml<sup>-1</sup> of murine IFN- $\gamma$  ( $\gamma$ ) for 24 hr prior to infection with bacteria. (C) Adherence (A) and internalization (I) assays were performed as described in materials and methods. Error bars represent  $\pm$  standard error.

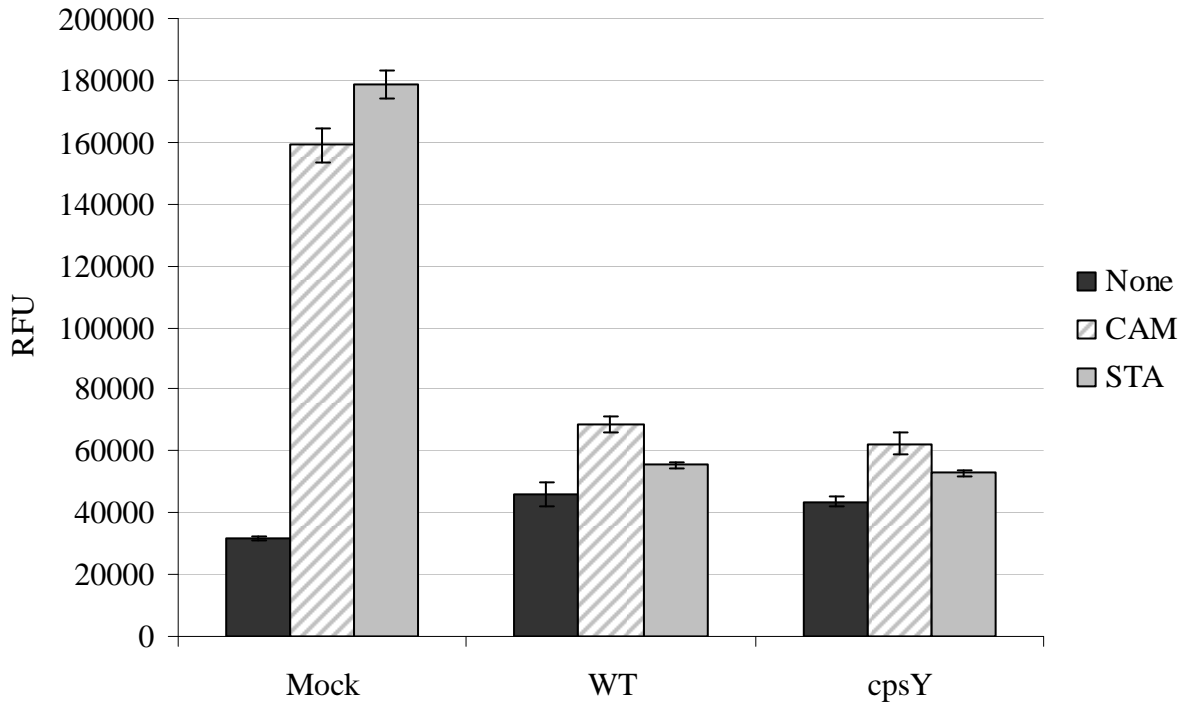


**Figure 10.** Live/Dead® fluorescent staining of *S. iniae*-infected macrophages. RAW 264.7 macrophages were infected with *S. iniae* WT or  $\Delta cpsY$  as described in materials and methods. At the indicated time points, cells were washed with 0.9% NaCl, and assayed for macrophage viability using the LIVE/DEAD® BacLight™ kit (Invitrogen) per manufacturer's instructions. White asterisk indicates the macrophage nucleus, and white arrows indicate *S. iniae*.

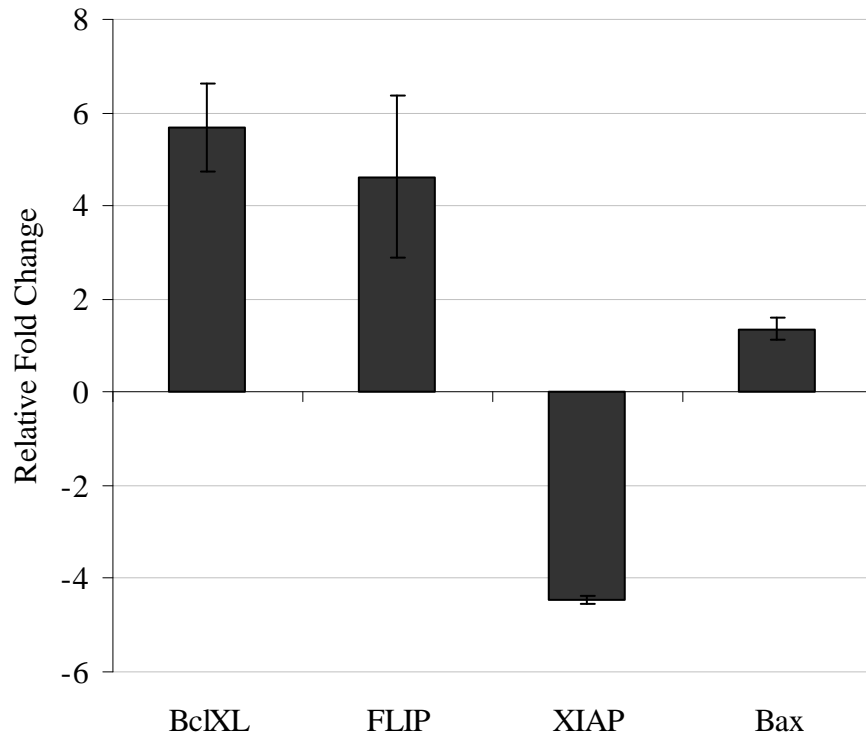
play an essential role during interactions with macrophages in vitro, and suggest an alternative role in *S. iniae* pathogenesis.

**Bacterial pathogen-associated molecular patterns prevent chemically-induced macrophage apoptosis in vitro.** Because *S. iniae*-infected macrophages remain viable though 48 hr post-infection, we sought to determine if this viability was a specific manipulation of the macrophage toward a pro-survival response, or if *S. iniae* simply was not actively killing the macrophage. Macrophages were infected as above for 24 hr, and assayed for the induction of apoptosis by measuring caspase 3 activity. Macrophages infected with either *S. iniae* WT or the  $\Delta cpsY$  mutant displayed minimal caspase 3 activity over mock-infected cells at 24 hours post-infection (Fig. 11), indicating that *S. iniae* does not induce apoptosis of macrophages. To determine whether *S. iniae* actively manipulates macrophages to protect against apoptosis, infected cells were treated with either 3  $\mu\text{M}$  camptothecin (CAM) or staurosporine (STA) to induce apoptosis. Mock-infected macrophages displayed a characteristic induction of caspase 3 activity in the presence of either inducer (Fig. 11). In contrast, CAM or STA-treated macrophages infected with either WT or the  $\Delta cpsY$  mutant showed no caspase 3 activity above background level (Fig. 11). The data suggest that *S. iniae*-infection of macrophages promotes a pro-survival response independent of CpsY, which can override the pro-apoptotic induction signals provided by CAM and STA. Quantitative PCR of *S. iniae* WT-infected macrophages revealed an increased expression of the pro-survival factors BclXL and FLIP, but a decreased expression of XIAP relative to mock treated macrophages (Fig. 12). BclXL and FLIP act on components associated with the initial induction of apoptosis signaling cascades, while XIAP acts to directly inhibit caspase 3. The data suggest that *S. iniae* induces a macrophage pro-survival response of specific apoptosis-related pathways upstream of caspase 3 activation.

To assess whether the macrophage pro-survival state was induced by an *S. iniae* secreted factor, macrophages were pre-treated for 24 hr with filtered culture supernatants (0.2 micron filter) from mid-



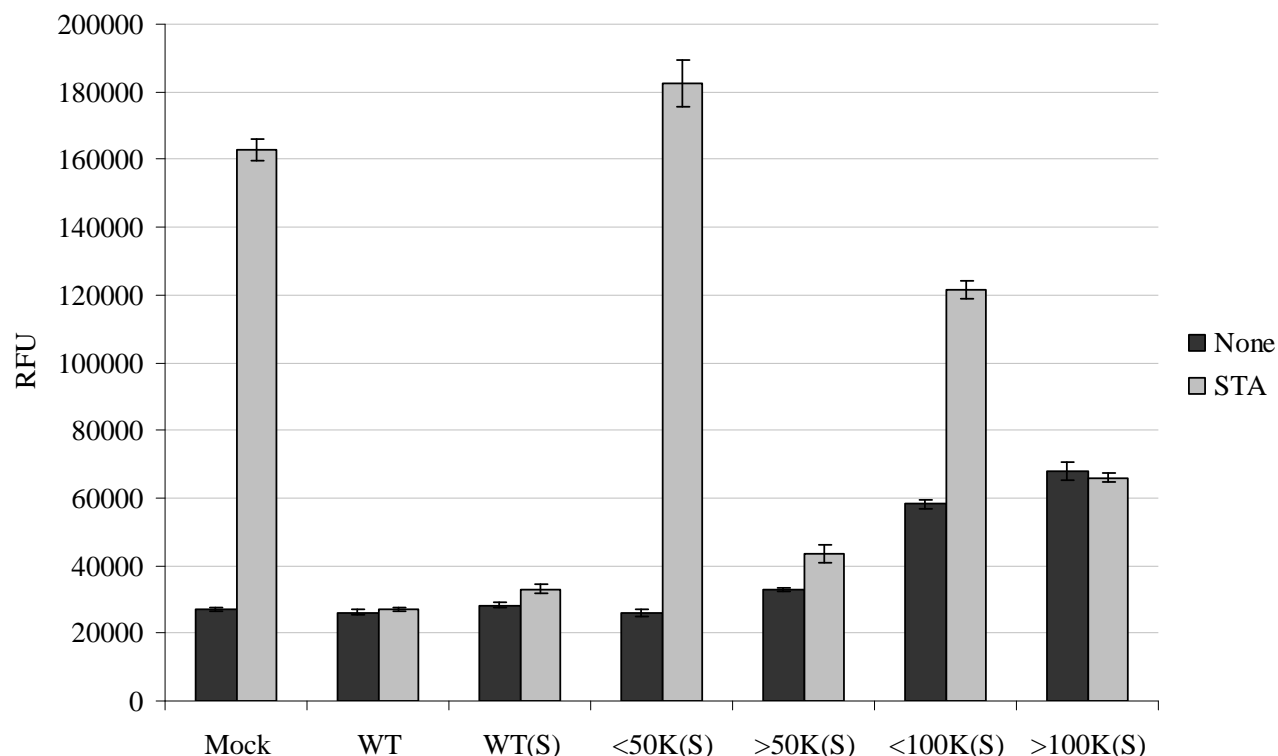
**Figure 11.** Macrophage apoptosis. RAW 264.7 macrophages were infected with *S. iniae* WT,  $\Delta cpsY$  or mock infected as described in materials and methods. At 21 hr post-infection cells were treated with 0.3  $\mu$ M staurosporine (STA, light grey bars), 1  $\mu$ M camptothecin (CAM, dashed grey bars) or left untreated (black bars) for 3 hr to induce apoptosis. At 24 hr post-infection induction of apoptosis was determined by measuring caspase 3 activity using the EnzChek Caspase 3 Assay Kit # 2 (Invitrogen). RFU, relative fluorescence units.



**Figure 12.** qPCR of *S. iniae*-infected macrophages. RAW 264.7 macrophages were infected with WT *S. iniae* and total RNA was isolated after 24 hours. Relative fold change gene expression compared to mock infection was determined by the  $2^{-\Delta\Delta CT}$  method.

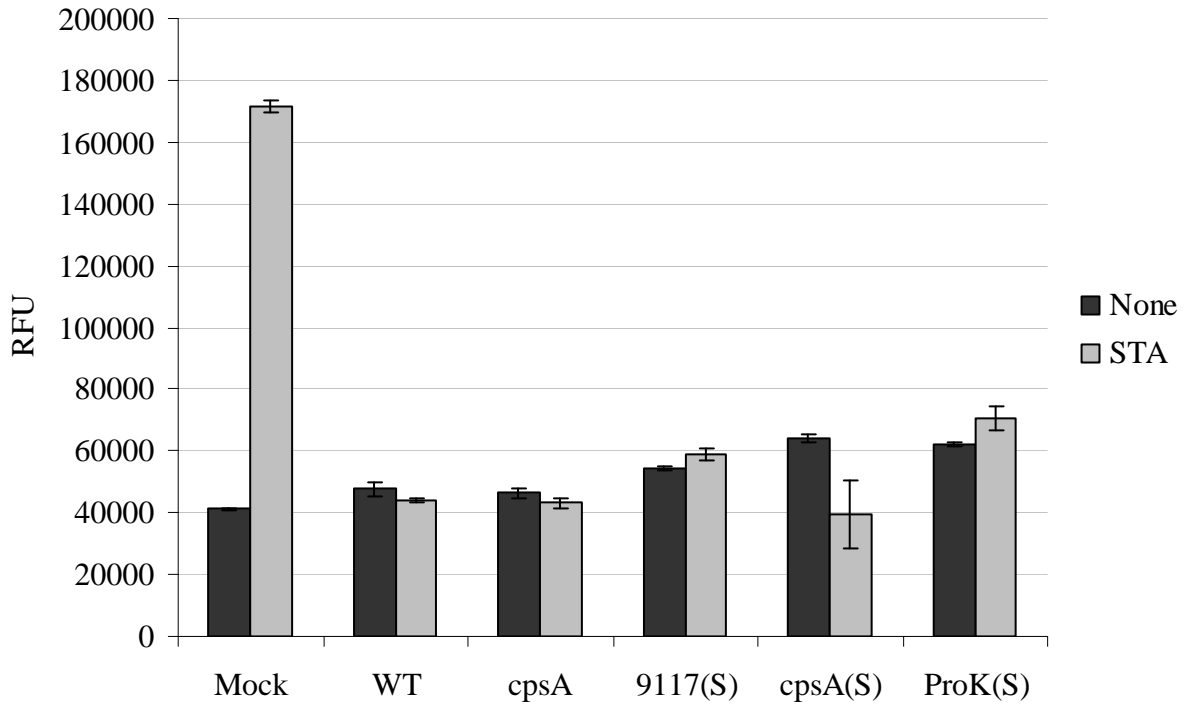
logarithmic phase growth, then treated with STA and assayed for caspase 3 activity as before. As observed with live cells, *S. iniae* culture supernatants were also able to provide protection against STA-induced apoptosis (Fig. 13), suggesting that the pro-survival inducing factor is either actively secreted or is released from the outer surface of the cell during growth. Using centrifugal filter units to fractionate the culture supernatants, the pro-survival inducing factor was determined to be > 100 kDa in size (Fig. 13). A slight reduction in STA-induced caspase 3 activity was observed in the fraction < 100 kDa suggesting that this factor may be a polymeric substance with subunits < 100 kDa (Fig. 13). A secreted or released substance of that size could be a large protein complex attached to the cell wall such as a pilus, or possibly related to the polysaccharide capsule. To determine whether capsule was responsible for this phenomenon, the same macrophage treatments were performed with either live bacteria or filtered culture supernatants from both WT *S. iniae* and a *cpsA*-insertional mutant, which contains a defect in capsule production (185). Macrophages treated with the *cpsA*-insertional mutant displayed no difference from WT treatment indicating that capsule was not involved (Fig. 14). Similar observations occurred when culture supernatants were pre-treated with proteinase K to remove any proteins (Fig. 14). Thus the pro-survival inducing factor appears to be a large proteinase K-resistant polymeric substance unrelated to capsule. This prompted examination of culture supernatants from a variety of other Gram positive and Gram negative bacteria to determine if this factor was a shared substance from all microorganisms such as peptidoglycan. Treatment of macrophages with filtered culture supernatants from *S. iniae*, *S. aureus*, *Escherichia coli*, *Vibrio cholerae*, *Lactococcus lactis* and *S. agalactiae*, as well as live *E. coli* was able to prevent STA-induced apoptosis (Fig. 15). The data indicate that the observed macrophage pro-survival response is not specific to *S. iniae*, but rather is a programmed macrophage response to the presence of microorganisms under these conditions.

**CpsY is essential for *S. iniae* survival in whole blood.** Systemic dissemination from the initial infection site requires a pathogen to effectively enter and survive in the blood stream. While in

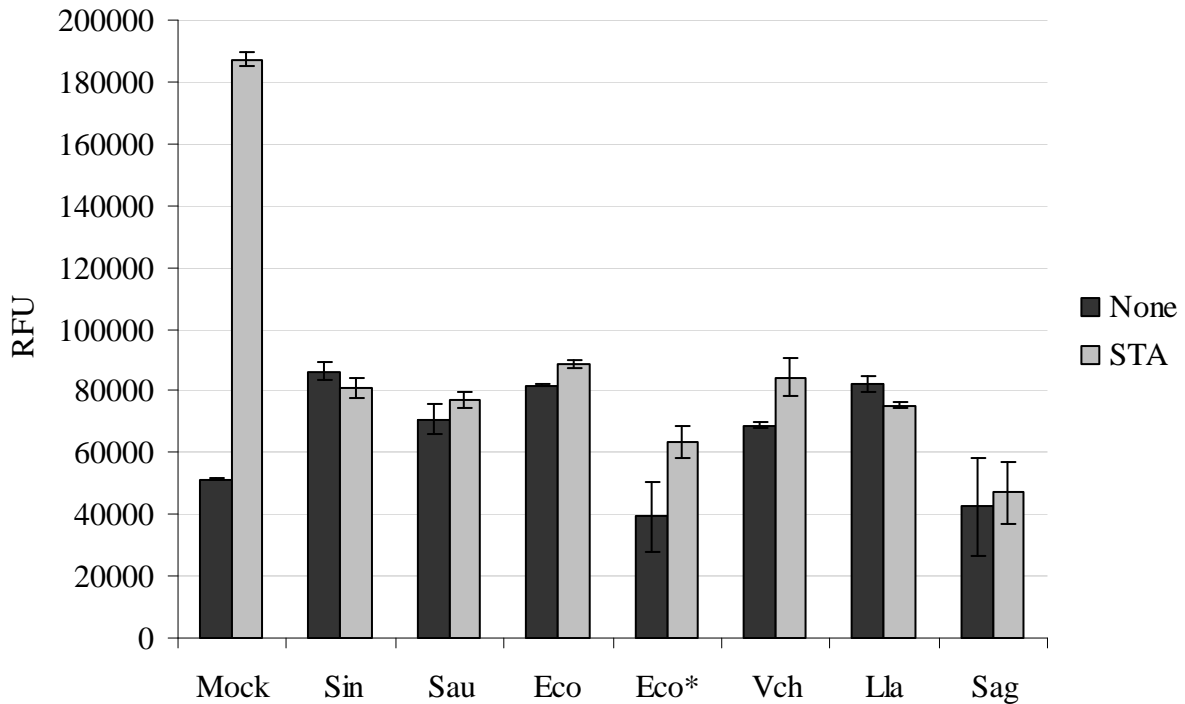


**Figure 13.** Macrophage apoptosis of *S. iniae* culture supernatant-treated cells. *S. iniae* mid-log phase culture supernatants grown in THY were filtered on a 0.2  $\mu\text{M}$  filter, and fractionated using a 50 kDa or 100 kDa cutoff centrifugal filter unit. RAW 264.7 macrophages were either infected with WT *S. iniae* as before, treated with the filtered culture supernatants (S) or mock infected for 24 hours as described in materials and methods. At 21 hr post-infection cells were treated 3 hr with 0.3  $\mu\text{M}$  staurosporine (STA, light grey bars) to induce apoptosis or left untreated (black bars). At 24 hr post-infection induction of apoptosis was determined by measuring caspase 3 activity using the EnzChek Caspase 3 Assay Kit # 2 (Invitrogen). RFU, relative fluorescence units.





**Figure 14.** Macrophage apoptosis. RAW 264.7 macrophages were infected with either WT *S. iniae* or a capsule-deficient mutant (*cpsA*), or treated with culture supernatants (S) from either strain for 24 hours as before. Additionally WT *S. iniae* supernatants were treated with proteinase K (ProK) for 3 hours prior to macrophage treatment. At 21 hr post-infection, cells were treated for 3 hr with 0.3  $\mu$ M staurosporine (STA, light grey bars) to induce apoptosis or left untreated (black bars). At 24 hr post-infection induction of apoptosis was determined by measuring caspase 3 activity using the EnzChek Caspase 3 Assay Kit # 2 (Invitrogen). RFU, relative fluorescence units.

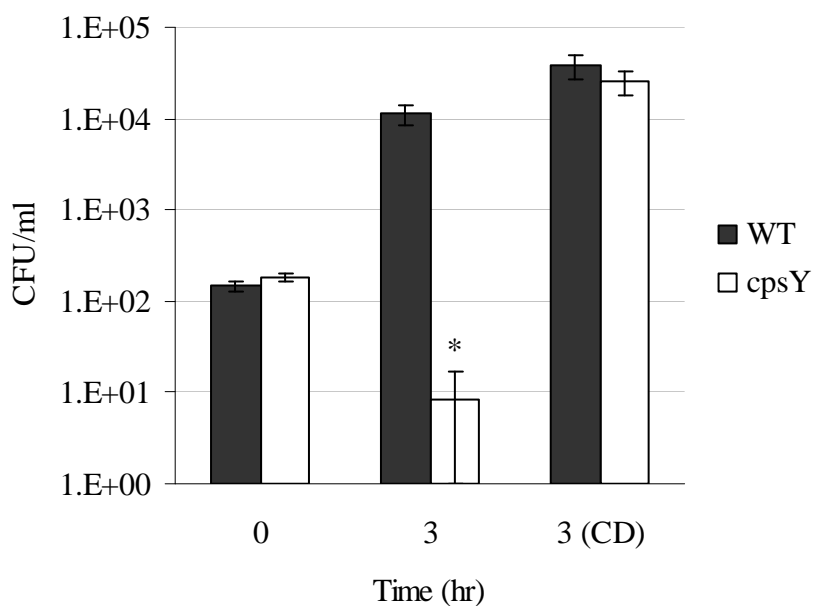


**Figure 15.** Macrophage apoptosis of cells treated with culture supernatants from a panel of bacteria. RAW 264.7 macrophages were treated with mid-logarithmic phase filtered culture supernatants for 24 hours as before. At 21 hr post-treatment cells were treated for 3 hr with 0.3  $\mu$ M staurosporine (STA, light grey bars) to induce apoptosis or left untreated (black bars). At 24 hr post-infection induction of apoptosis was determined by measuring caspase 3 activity using the EnzChek Caspase 3 Assay Kit # 2 (Invitrogen). RFU, relative fluorescence units. Sin, *Streptococcus iniae*; Sau, *Staphylococcus aureus*; Eco, *Escherichia coli*; Vch, *Vibrio cholerae*; Lla, *Lactococcus lactis*; Sag, *Streptococcus agalactiae*. Eco\*, live *E. coli*-treatment.

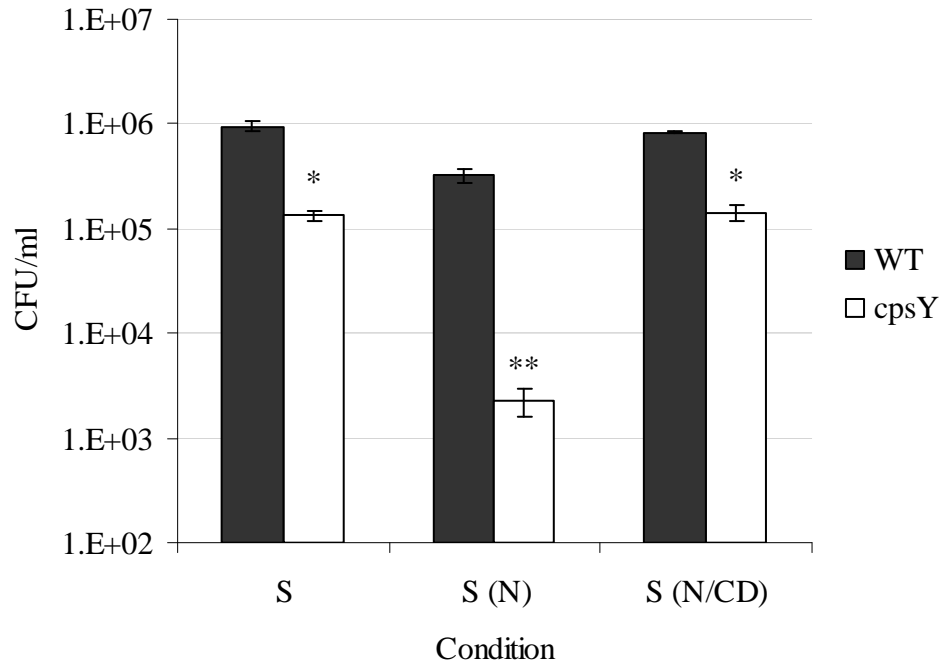
the blood stream a pathogen must withstand immune clearance by blood leukocytes. Because the  $\Delta cpsY$  mutant was unable to disseminate to the brain, the requirement of CpsY for *S. iniae* survival in whole blood was investigated. Both WT *S. iniae* and the  $\Delta cpsY$  mutant were incubated in human whole blood for 3 hr and serially diluted onto THY agar plates to determine bacterial survival. WT *S. iniae* displayed an ability to replicate in whole blood, reaching levels approximately 2 logs over the inoculum ( $p < 0.05$ ), while the  $\Delta cpsY$  mutant was almost completely killed under the same conditions ( $p < 0.05$ ) (Fig. 16). To determine if this difference in bacterial survival was due to phagocytic killing by blood leukocytes, whole blood was pretreated for 30 min with cytochalasin D (CD), an inhibitor of actin polymerization, to block phagocytosis. The addition of CD completely rescued the  $\Delta cpsY$  mutant to WT levels (Fig. 16). These results suggest that leukocyte phagocytic killing is the primary bactericidal force against the  $\Delta cpsY$  mutant, and indicate a function for CpsY in the regulation of factors required for protection of *S. iniae* from phagocytic clearance.

**CpsY protects *S. iniae* from neutrophil intracellular killing.** To confirm that blood leukocytes were responsible for the extensive killing of the  $\Delta cpsY$  mutant in whole blood, *S. iniae* WT and the  $\Delta cpsY$  mutant were incubated 3 hr in either 50% human serum alone or with the addition of primary peripheral blood neutrophils. Significant growth was observed for both WT and the  $\Delta cpsY$  mutant in 50% human serum alone ( $p < 0.0001$ ) (Fig. 17). Addition of neutrophils resulted in a reduction of WT compared to serum alone ( $p = 0.0005$ ) (Fig. 17), which was still significant growth over the inoculum ( $p < 0.0001$ ). In contrast, the  $\Delta cpsY$  mutant was highly attenuated with the addition of neutrophils ( $p = 0.0001$  compared to serum alone) (Fig. 17). Pretreatment of the neutrophils with CD rescued both WT and the  $\Delta cpsY$  mutant back to the levels observed in serum alone (Fig. 17), confirming the phenotype found in the whole blood.

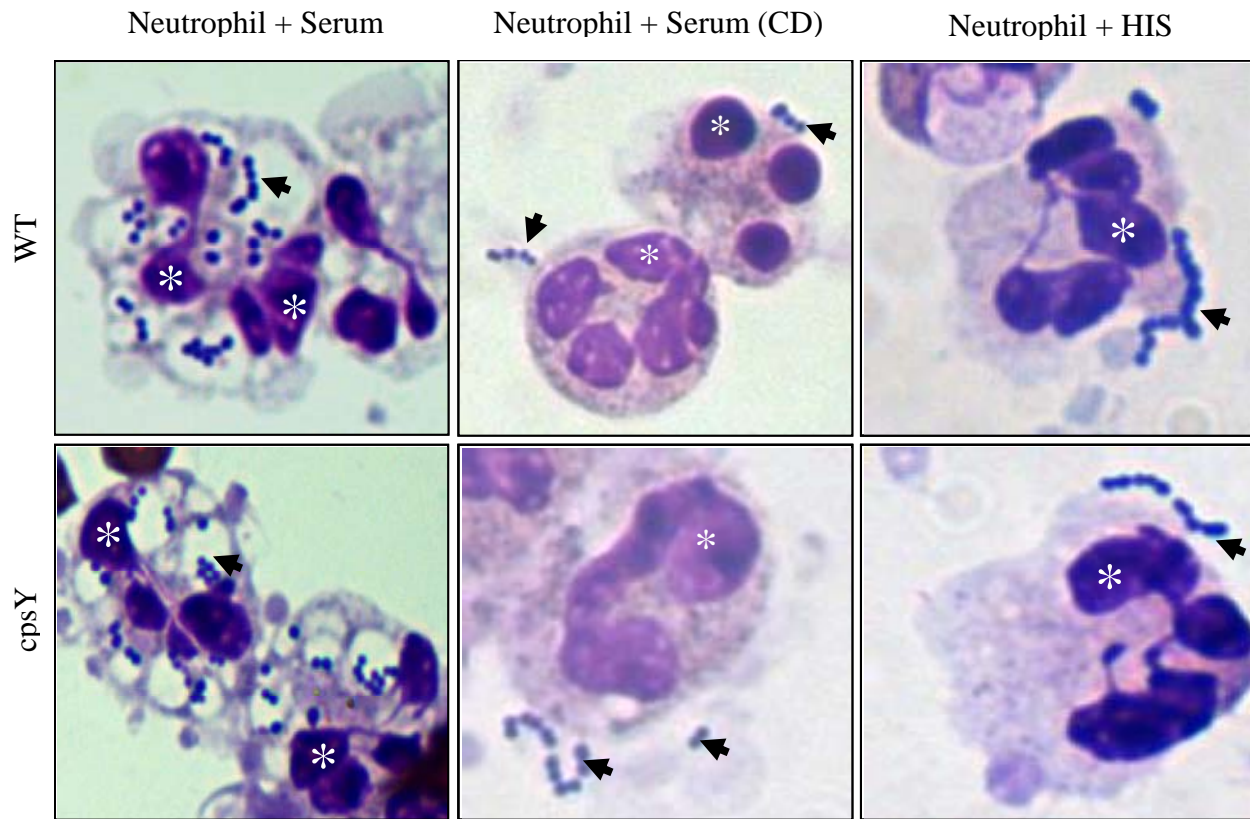
HEMA-stained cyospin slide preparations of infected neutrophils (in 50% human serum) revealed intracellular localization of both WT and the  $\Delta cpsY$  mutant within a vacuole (Fig. 18).



**Figure 16.** *S. iniae* survival in human whole blood. Mid-log phase cultures of *S. iniae* WT (grey bars) or  $\Delta cpsY$  (white bars) were diluted into 1 ml heparinized human whole blood, and incubated at 37 °C with gentle rotation. Samples were serially diluted and plated on THY for enumeration of bacterial CFU. For certain conditions blood was pretreated for 30 min with 10  $\mu\text{g ml}^{-1}$  cytochalasin D (CD). Error bars represent  $\pm$  standard error. \* $p < 0.05$  compared to WT.



**Figure 17.** *S. iniae* neutrophil infections. Mid-logarithmic cultures of *S. iniae* WT (grey bars) or  $\Delta cpsY$  (white bars) were diluted 1 ml DMEM 50 % human serum. When necessary, human primary neutrophils (N) were added to a final MOI of 0.001 (bacteria:neutrophil). If required, neutrophils were pretreated with 10  $\mu\text{g ml}^{-1}$  cytochalasin D (CD) for 30 min. Samples were incubated at 37 °C with gentle rotation, followed by serial dilution and plating on TP for enumeration of bacterial CFU. Error bars represent  $\pm$  standard error. \*  $p < 0.01$ , \*\*  $p = 0.0001$  compared to WT.



**Figure 18.** Images of *S. iniae* neutrophil infections. *S. iniae* WT or  $\Delta cpsY$  were mixed with neutrophils suspended in 1 ml DMEM with 50 % serum alone, with cytochalasin D pretreatment (CD), or with 50 % heat-inactivated serum (HIS). After 3 hrs 100  $\mu$ l of the sample was cytocentrifuged on to glass slides and stained for visualization. A representative image for each condition is shown. Black arrows depict bacteria. Cell nuclei are noted with a white asterisk.

Pretreatment with CD completely inhibited phagocytosis, but the bacteria remained closely associated to the neutrophil outer surface (Fig. 18). Similar observations were made when serum was heat inactivated prior to infection (Fig. 18). Thus, *cpsY* is not involved in preventing phagocytic uptake, but rather must function to protect *S. iniae* within the neutrophil phagosome.

## Discussion

Bacteria have a variety of mechanisms for maintaining the required supply of nutrients needed for survival in nutrient-limited environments by either de-novo synthesis or nutrient scavenging from the external environment. While many of these pathways are functionally conserved in both Gram-positive and Gram-negative bacteria, others differ markedly even within the same genera. Streptococcal species appear to use the same general pathway for managing intracellular methionine supply, although portions of the pathway appear to be missing in some species (Table 1).

The current collection of information on the streptococcal CpsY regulon is focused on its role in methionine metabolism and uptake (259, 268). De-novo biosynthesis of methionine begins with the generation of homocysteine through transsulfuration (MetB, MetI, MetC), direct sulfhydrylation (MetB, MetY) or *S*-adenosylmethionine (SAM) recycling (MetK, Pfs, LuxS) pathways (Fig 6). Homocysteine is then converted to methionine by the cobalamin-independent methionine synthase (MetE) and 5,10-methylenetetrahydrofolate reductase (MetF) (268). Portions of these pathways are incomplete in *S. iniae*, *S. agalactiae* and *S. pyogenes* (Table 1) (248) and in these pathogens incomplete de-novo biosynthesis is thought to be balanced by environmental methionine scavenging through the conserved AtmBDE (MetQ1NP, also called Abc,YaeEC) ABC transport system (248).

A comprehensive understanding of how streptococci regulate their repertoire of methionine metabolic genes is still emerging. In Gram negative organisms, the MetJ repressor along with the SAM cofactor controls transcription of the de novo methionine biosynthesis genes and the *atmBDE* locus when methionine levels are sufficient (169). Repression is relieved under sulfur limiting conditions when methionine biosynthesis is required (113). In addition, the CpsY ortholog MetR utilizes homocysteine as a cofactor to compete with the MetJ:SAM complex and increases methionine biosynthesis through transcriptional activation of *metE* and *metF* when methionine levels are insufficient (47, 65, 183, 234, 290-291).



MetR is thought to be the primary regulator of methionine biosynthesis and uptake pathways for streptococcal species due to the absence of a MetJ ortholog (158). In *S. mutans*, MetR-dependent activation of *metE* and *atmBDE* occurs under methionine-limitation but not excess (268). Expression of *metE* and *atmB* can be triggered in the presence of excess methionine only if excess homocysteine is also present in the medium, because homocysteine is the activating co-factor for MetR (268). In *S. agalactiae*, MtaR was shown to activate *metQ1* (*atmB*) in the presence of excess methionine, but had no effect on *metE* expression (42). The effect on *metQ1* or *metE* in the absence of methionine was not investigated in that study. *S. iniae* does not carry the *metE* or *metF* genes, but does contain genes encoding the AtmBDE transporter. We show here that a CpsY-dependent increase in *atmB* expression occurs in the presence of excess methionine, but not homocysteine. Thus as observed in other species, CpsY appears to increase cellular methionine pools through transcriptional activation of the AtmBDE transport system; however, the environmental condition under which this occurs differs between species. Those species which contain a complete de novo methionine biosynthesis pathway (i.e. *S. mutans*) limit expression of *atmB* in the presence of excess methionine and respond to homocysteine, whereas those with incomplete pathways (i.e. *S. iniae*) increase expression of the transporter and do not respond to homocysteine. This difference is not due to alterations in the promoter structure because a canonical Met box (TATAGTTTnAAACTATA) was found in the same proximal location to *atmB* in all species. This may possibly be due to differences in CpsY itself or additional regulatory elements that function either in *cis* or in *trans* to influence the regulation of this locus.

The physiological explanation for these observed differences in *S. iniae* has yet to be determined, but may be due in part to the absence of both MetE and MetF for conversion of homocysteine to methionine. This conversion is a key step in recycling of the primary methyl donor SAM (307). An inability to convert homocysteine back to methionine due to the absence of MetEF would necessitate methionine scavenging for generation of SAM. Thus *S. iniae* may have evolved alternate regulatory mechanisms to compensate for the lack of MetEF. *S. pyogenes*, *S. uberis* and *S.*

*equi* also do not have the *metEF* genes (158), but whether their respective CpsY orthologs function similar to *S. iniae* is unknown.

A systemic pathogen must adapt to one or more environments in the host and, as has been shown for many pathogens, these adaptations involve metabolic changes. The work presented here demonstrates a specific role for CpsY during *S. iniae* systemic infection. In addition to control of methionine transport through regulation of the *atmB* gene, CpsY is critical for adaptation and survival in the intracellular environment of neutrophils in whole blood. The enhanced susceptibility of the  $\Delta cpsY$  mutant to neutrophil-mediated killing correlates with the attenuation initially observed in our zebrafish infection model (185).

While CpsY is absolutely required for *S. iniae* survival in neutrophils, it appears dispensable for survival in macrophages. This is supported in vivo where localization of *S. iniae* within splenic macrophages of infected zebrafish is independent of CpsY. Contradictory was the observation that intracellular localization within zebrafish macrophage-like cells in the brain is dependent upon CpsY. An explanation for this dichotomy in vivo may be that the ability to survive and replicate in the blood stream is a precursor for the establishment of a CNS infection (43, 84, 240, 318). Thus, the inability of the  $\Delta cpsY$  mutant to localize within brain macrophages could be due to limited bacteremia in vivo, and not susceptibility to macrophage-mediated killing within the brain. If the  $\Delta cpsY$  mutant were rapidly cleared in the blood stream by neutrophils, then a decrease in the bacterial load at distant sites would be expected. This explanation correlates with previous reports where the  $\Delta cpsY$  mutant displayed a unique inability to acutely disseminate to the brain 30 minutes post intramuscular infection, while bacterial loads in the spleen were equal to WT (185). Neutrophils are the primary phagocytic cell found in the blood stream, and are vital for protection from invading pathogens (175). The ability to exploit the host inflammatory response and survive within neutrophils is an important virulence trait of

several pathogens including *Staphylococcus aureus* (110), *Streptococcus pyogenes* (196), *Streptococcus suis* (306) and *Listeria monocytogenes* (81).

Mutations in orthologs of CpsY have been shown to influence growth in vitro due to the disruption of methionine supply described above. This defect could be rescued with the addition of exogenous methionine for *S. agalactiae* (42, 259) and *S. mutans* (268), but as shown here, not for *S. iniae*. In contrast, addition of 2% proteose peptone resulted in unrestricted exponential growth for the  $\Delta cpsY$  mutant while growth of the WT strain was unaffected. The data suggest that in *S. iniae*, CpsY functions to maintain proper growth in vitro in a way that differs from *S. agalactiae* or *S. mutans*. The inability of the  $\Delta cpsY$  mutant to maintain proper growth in vitro does not appear to be the cause of its virulence attenuation. The  $\Delta cpsY$  mutant was highly attenuated in whole blood, but was able to grow to WT levels upon inhibition of neutrophil phagocytosis by the addition of CD. Thus the attenuation observed in whole blood is not due to a growth defect, but specifically the inability to survive neutrophil phagocytosis. The sensitivity to phagocytosis is specific to neutrophils because growth in macrophages was unaltered. Overall the data suggest that CpsY provides a unique virulence function that allows *S. iniae* to adapt for intracellular survival within neutrophils. The growth disparity observed for the  $\Delta cpsY$  mutant in vitro appears to reflect an early entry into stationary phase, which could suggest a defect in cell wall biosynthesis, cell stress response pathways or autolysin regulation rather than an auxotrophic phenotype (245).

CpsY orthologs have also been implicated in the regulation of genes unrelated to methionine acquisition. *S. agalactiae* MtaR affects the expression of a cell surfaces protease (*cspA*) and fibrinogen binding protein (*fsbB*) implicated in streptococcal pathogenesis, as well as numerous genes involved in arginine transport and sugar metabolism (42). In *Pseudomonas aeruginosa*, MetR has significant effects on swarming motility in semi-viscous media, and was shown to control several transcriptional regulators, a Type III secretion system, as well as pyoverdine and pyochelin synthesis genes (312).

Furthermore, MetR in *Vibrio harveii* was shown to act directly on the *luxCDABE* operon to repress luminescence independent of the quorum sensing AI1 and AI2 signal levels (57).

The data presented here demonstrate that CpsY has a pleiotropic regulatory effect on *S. iniae* pathogenesis that extends beyond the traditional methionine metabolic processes. Furthermore, CpsY may have been co-opted to provide regulatory input on virulence gene expression based on the nutritional status of the cell. Moreover, *S. iniae* provides a unique model to investigate the paradigm of CpsY-dependent regulation during systemic streptococcal infection due to the absence of a methionine-dependent growth deficiency.

**CHAPTER 3****CpsY-dependent protection from neutrophil-mediated killing involves modification and stabilization of the *Streptococcus iniae* cell wall****Abstract**

The ability of a pathogen to evade neutrophil phagocytic killing mechanisms is critically important for dissemination and establishment of a systemic infection. Understanding how pathogens overcome these innate defenses is important for the development of optimal therapeutic strategies for invasive infections. CpsY is a conserved transcriptional regulator previously identified as an important virulence determinant for systemic infection of *Streptococcus iniae*. While orthologs of CpsY have been associated with the regulation of methionine metabolism and uptake pathways, CpsY additionally functions in protection from neutrophil-mediated killing. *S. iniae* does not alter neutrophil phagosomal maturation, but instead is able to adapt to the extreme bactericidal environment of a mature neutrophil phagosome dependent upon CpsY. This CpsY-dependent adaptation appears to involve stabilization of the cell wall through peptidoglycan *O*-acetylation and repression of cellular autolysins. In addition, CpsY may influence these processes by responding to nutritional stress.. Furthermore *S. iniae* proves to be a powerful model to investigate bacterial adaptations during systemic streptococcal infection.

## Introduction

The ability of a systemic pathogen to evade or manipulate the host innate immune response is a key factor in determining the severity of a bacterial infection (289). Polymorphonuclear leukocytes (neutrophils) are a primary bactericidal force against invading bacteria, and represent a formidable obstacle for pathogens to overcome (33). This is especially reflected in the susceptibility of patients with inherited neutrophil disorders to severe bacterial infections (191). Neutrophils are efficient at eliminating invading pathogens through both intracellular (256) and extracellular killing mechanisms (222). Engulfed pathogens suffer a barrage of bactericidal attacks from exposure to reactive oxygen and nitrogen species (172, 256), antimicrobial peptides (104, 241), proteases (48, 250, 264) peptidoglycan degrading enzymes (211), and metal deprivation (135, 154, 217).

Invasive pathogens have evolved several strategies for evasion of neutrophil killing mechanisms. Pathogens attempt to avoid phagocytic uptake through prevention of opsonin deposition (282) and production of a polysaccharide capsule (179). Engulfed pathogens can either disrupt phagosomal maturation, escape into the cytoplasm or adapt for survival within the mature phagosome (289). Adaptive processes for phagosomal survival occur in part through chemical modification of outer surface structures including lysinylation of lipid membranes (92, 162, 251), D-alanylation of wall teichoic acids (55, 100) and *O*-acetylation of *N*-acetylmuramyl peptidoglycan residues (20-21, 68).

*Streptococcus iniae* is an invasive pathogen of aquatic species that causes severe bacteremia and meningoencephalitis (4, 88-89). The rapid dissemination of *S. iniae* to systemic sites reflects its ability to survive and replicate in the blood stream (43, 101, 185). CpsY is a conserved transcriptional regulator previously identified as an important virulence determinant for systemic infection of *S. iniae* (185), and mutants of *cpsY* are specifically susceptible to neutrophil-mediated killing in whole blood (Fig. 16). CpsY is orthologous to the MetR transcriptional regulator associated with methionine metabolism and uptake pathways in Gram negative and Gram positive microorganisms. MetR increases cellular methionine pools in *Streptococcus mutans* and *Streptococcus agalactiae* through

transcriptional activation of both an ABC transport system and methionine synthase (MetE) (42, 268). Mutants of *metR* in these species display a severe growth defect and require exogenous methionine for optimal growth (42, 268). *S. iniae* does not contain an ortholog of *metE*, but CpsY does function as a transcriptional activator of the methionine ABC transporter. In contrast to *S. mutans* and *S. agalactiae*, however, the effect of CpsY on growth of *S. iniae* is independent of exogenous methionine. Rather, a strain deleted for the *cpsY* gene ( $\Delta cpsY$ ) displays aberrant growth patterns, with final cell densities at stationary phase reaching levels either significantly greater or less than WT dependent upon media conditions. Furthermore, growth of the  $\Delta cpsY$  mutant could not explain the severe susceptibility to neutrophil-mediated killing in whole blood. Thus the CpsY regulon must allow *S. iniae* to specifically adapt for intracellular survival in neutrophils by a previously undetermined mechanism.

This work elucidates the role of CpsY for *S. iniae* intracellular survival in neutrophils. *S. iniae* does not appear to disrupt neutrophil phagosomal maturation, instead the CpsY regulon protects *S. iniae* from the bactericidal components contained within a mature phagosome. This protection appears to be mediated in part by modifications to the peptidoglycan cell wall and repression of streptococcal autolysins. Furthermore, we discuss how CpsY-dependent regulation of methionine supply pathways may influence these processes.

## Materials and Methods

**Bacterial strains, media and culture conditions.** The parent *S. iniae* strain 9117 and a *cpsY* in-frame deletion mutant ( $\Delta cpsY$ ) used in this study have been described previously (185). All plasmid constructs were propagated using *Escherichia coli* TOP10 cells (Invitrogen) cultured in Luria-Bertani (LB) medium. Streptococcal strains were cultured in Todd-Hewitt broth (BBL) supplemented with 0.2% yeast extract (BBL) (THY) (189). Antibiotics were added to the medium when required at the following concentrations: Kanamycin 25  $\mu\text{g ml}^{-1}$  or chloramphenicol 750  $\mu\text{g ml}^{-1}$  for *E. coli*; Kanamycin 500  $\mu\text{g ml}^{-1}$ , chloramphenicol 3  $\mu\text{g ml}^{-1}$  or streptomycin 1  $\text{mg ml}^{-1}$  for *S. iniae*. Bacteria were routinely cultured overnight, diluted 1:50 in fresh medium, and grown to mid-exponential phase ( $\text{OD}_{600} = 0.225$ ) unless otherwise stated. Bacterial growth curves were performed in 96-well plates as described in Chapter 2.

**Construction of *S. iniae* overexpression mutants.** The primers 5' *murA*.PstI (AAAACCTGCAGGAGAAGAAGAATAAAGCCTATAGTG) and 3' *murA*.ApaI (TTGGGCCCCTAAAGGCCTTTATTTGTCTTTG) were used to amplify an 860 base pair (bp) fragment containing the MurNAc-L-alanine amidase (*murA*) (sin.1445). The fragment was inserted into the PstI/ApaI sites of the vector pLZ12-km (116) generating pLZ12-km-*murA*. The promoter of the hyaluronic acid synthesis operon in *Streptococcus pyogenes* (67) was PCR amplified using primers 5' *hasA*pro.BglII (GGAAGATCTCAGATGAAGTTGTACTCCCTG) and 3' *hasA*pro.BamHI (CGCGGATCCGGCAC AATTACACCTCTTC). This fragment was inserted into the BglII/BamHI sites in pLZ12-km-*murA* to generate the final construct pLZ12-*hasA*pro.*murA*.

The vector pLZ12-km-*hasA*pro.*murA* was cut with PstI and ApaI to remove *murA* generating pLZ12-km-*hasA*pro. The primers 5' *oatA*.PstI (TGCACTGCAGCTTTAAACAGGGGATTTATCAAA AATG) and 3' *oatA*.ApaI (TGGGGGCCCCGACCTTATTTGGCCTTATTTTTG) were used to PCR amplify an 1815 bp fragment containing the peptidoglycan *O*-acetyltransferase (*oatA*) (Sin.29). This



fragment was inserted into the PstI/ApaI sites of pLZ12-km-*hasApro* to generate the final construct pLZ12-km-*hasApro.oatA*. Both pLZ12-km-*hasApro.murA* and pLZ12-km-*hasApro.oatA* were transformed into *S. iniae* as previously described (201).

**Whole blood and neutrophil infection assays.** Primary neutrophils were isolated from human whole blood, and infections were performed in either whole blood or neutrophil preparations as described in Chapter 2. For competition assays, neutrophils were infected as before with minor variations. Mid-exponential phase cultures were adjusted to  $1 \times 10^5$  CFU ml<sup>-1</sup> in PBS, from which equal volumes were pooled and inoculated 1:50 (20  $\mu$ l volume) into 1 ml neutrophil preparations. Samples were incubated at 37 °C for 3 hr with gentle rotation, followed by serial dilution and replica plating on THY agar  $\pm$  1000  $\mu$ g ml<sup>-1</sup> streptomycin for bacterial enumeration. The competitive index (CI) was calculated by dividing the output ratio (mutant/wild type) by the input ratio (mutant/wild type).

**Confocal laser scanning fluorescence microscopy.** *S. iniae* neutrophil infections were performed as above for 1 hr. One hundred microliters of the sample was loaded into a cytology funnel (Thermo), centrifuged onto glass slides for 3 min at 700 rpm in a Cytospin 1 centrifuge (Shandon Elliott) and fixed in 4% paraformaldehyde (Sigma) for 15 min at room temperature. Fixed cells were washed 3 times in PBS and treated for 30 min with 100  $\mu$ l of permeabilization buffer (0.2% Tween 20 in PBS + 10% mutanolysin). Cells were washed in PBS and covered for 30 min in blocking buffer (2% cold water fish gelatin (Sigma) in PBS). One hundred microliters of a polyclonal anti-*S. iniae* antibody was added to the cells for 2 hr, followed by washing 3 times in PBS. One hundred microliters of a secondary Alexa Fluor<sup>®</sup> 488-conjugated goat anti-rabbit antibody (Molecular Probes) was added to the cells for 30 min, and again washed 3 times with PBS. This procedure was repeated a second time using a monoclonal antibody specific for human PMN secondary granule marker CD107A (LAMP1) (Santa Cruz Biotechnology) and a secondary Alexa Fluor<sup>®</sup> TRITC-conjugated goat anti-

mouse antibody (Molecular Probes), or using a primary goat antibody for staining of human PMN azurophil (primary) granule marker CD63 (Santa Cruz Biotechnology) and a secondary rhodamine-conjugated chicken anti-goat antibody (Santa Cruz Biotechnology). Prepared cells were mounted in ProLong<sup>®</sup> Gold antifade reagent with DAPI (Molecular Probes). Co-localization was determined by fluorescent microscopy using a Leica TCS SP5 Laser Scanning Confocal Microscope.

**Antimicrobial sensitivity assays.** Working concentrations of the following antimicrobials were prepared in THY broth: colistin (500  $\mu\text{g ml}^{-1}$ ; Sigma), gramicidin (1.5  $\mu\text{g ml}^{-1}$ ; Sigma), carbenicillin (6  $\mu\text{g ml}^{-1}$ ; Sigma), methicillin (16  $\mu\text{g ml}^{-1}$ ; Sigma), teicoplanin (0.07  $\mu\text{g ml}^{-1}$ ; Sigma), bacitracin (5  $\mu\text{g ml}^{-1}$ ; Sigma), nisin (40  $\mu\text{g ml}^{-1}$ ; Sigma) and LL-37 (500  $\mu\text{g ml}^{-1}$ ; Anaspec). Three hundred microliter stock solutions were added to the last column of a 96-well flat bottom plate, and serially diluted 1:2 into 150  $\mu\text{l}$  of THY broth. For lysozyme treatments, wells were prepared with increasing concentrations of chicken egg white lysozyme (Sigma, 40K units  $\text{mg}^{-1}$ ) from 2.5  $\text{mg ml}^{-1}$  to 25  $\text{mg ml}^{-1}$  in 150  $\mu\text{l}$  total volume THY broth. Mid-exponential phase bacterial cultures were washed twice in PBS and normalized to  $1 \times 10^5$  CFU  $\text{ml}^{-1}$ . Ten microliters of this resuspension was added to each well, and plates were incubated overnight at 37°C. OD<sub>600</sub> readings were measured using a VersaMax microplate reader (Molecular Diagnostics). The minimal inhibitory concentration (MIC) was scored as the lowest antimicrobial concentration with no detectable growth. For assays using LL-37 antimicrobial assays were performed as described above except PBS was used in place of THY broth. Plates were incubated at 37°C for only 3 hr, followed by serial dilution and plating on THY agar. Minimal bactericidal concentration (MBC) was scored as the lowest antimicrobial concentration with no detectable growth.

**Bacterial surface charge assay.** Bacteria grown in THY medium were normalized to an OD<sub>600</sub> = 6.0. Cultures were washed 2 times in 20 mM morpholinepropane-sulfonic acid (MOPS) buffer (pH 7.0) and resuspended in 1 ml of the same buffer. Ten microliters of 50  $\text{mg ml}^{-1}$  cytochrome

*c* (Sigma) was added, mixed well and incubated 15 min at room temperature. Samples were centrifuged 13,000 x *g* for 5 min, supernatants were collected and measured at OD<sub>530</sub> to determine the amount of cytochrome *c* remaining. Tubes containing no bacteria were used as an input control. The percentage cytochrome *c* bound was calculated with the following formula: [1- (output OD<sub>530</sub>/input OD<sub>530</sub>)] x 100.

**RNA isolation and quantitative PCR.** Ten milliliters of bacterial cultures were used to purify total RNA as described in chapter 2. For synthesis of cDNA, 2 µg of total RNA was combined in 20 µl reaction volumes with 0.2 µM reverse primer mix (4 µM mixture of each of the reverse primers listed below), 0.5 mM dNTP mix, 1X RT buffer, and 200 U of Maxima<sup>®</sup> Reverse Transcriptase (Fermentas). Reactions were incubated at 60 °C for 30 min followed by 85 °C for 5 min. For qPCR reactions, 1 µl of cDNA was combined in 20 µl total reaction volumes with 0.2 µM forward and reverse primers, and 1X Maxima<sup>®</sup> SYBR Green master mix (Fermentas) per manufacturer instructions. Primer sequences are as follows: *recA* (sin.996) fwd 5'-CTCAGGTGCTGTTGATTTGG-3', rev 5'-TGCAGAGAGTTTACGCATGG-3'; *murA* (sin.1445) fwd 5'-CGTAGTCGTGTATTT-3', rev 5'-TTGGGTTGTATGGTGAAGCA-3'; *oatA* (sin.29) fwd 5'-CTTTTCGGCTTTGTTCTTGC-3', rev 5'-TCCGCAAAGTATGTCAGCAC-3'; *dltA* (sin.295) fwd 5'-CACCGGTATGGTAAGCAGGT-3', rev 5'-AAACGGAGAGCAAGGTGAAA-3'; *pgdA* (sin.822) fwd 5'-GATGGTCCAAACCCTGTGAC-3', rev 5'-ACCCGCTTCCTTGACTTTTT-3'; *tagO* (sin.1228) fwd 5'-GGTTCCTATGCCAAGTGGTG-3', rev 5'-ATTGCCGCTCCAATAACAAC-3'. Reactions were performed in triplicate using a BioRad *iCycler* with the following cycling conditions: 10 min at 95 °C, 40 cycles of 15 sec 95 °C and 1 min 60 °C. Melting curves were performed after completion of each experiment. Relative fold change in gene expression was calculated by 2<sup>-(ΔΔCT)</sup> as described in chapter 2.

**Isolation and purification of peptidoglycan.** *S. iniae* strains subcultured in 1 L of THY at 37 °C to early stationary phase were rapidly cooled on ice for 5 min, and harvested by centrifugation

(9,000 x g, 4°C) for 10 min. The pellet was resuspended in 15 ml of cold water and transferred dropwise into 50 ml of boiling 4% sodium dodecyl sulfate (SDS) (Sigma) for 30 min. The SDS insoluble fraction was collected by centrifugation (9,000 x g, 25°C) for 10 min, and washed with 60 °C water until the SDS was undetectable by methylene blue assay (120). The cell wall fraction was resuspended in 1 ml of 100 mM Tris-HCl (pH 7.5), 20 mM MgSO<sub>4</sub> containing 10 µg ml<sup>-1</sup> DNaseI (Qiagen), 250 µg ml<sup>-1</sup> RNaseA (Qiagen) and incubated for 2 hr at 37 °C. Calcium chloride was adjusted to a final concentration of 10 mM, and 100 µg Trypsin was added to the mixture prior to incubation overnight at 37 °C. The samples were boiled in 1% SDS for 5 min to denature trypsin, and the samples were washed clean of SDS as before. The purified peptidoglycan was lyophilized and stored for later analysis.

**Analysis of muropeptide composition.** Muropeptides were analyzed as previously described with minor variations (174). Five milligrams of lyophilized cell wall preparations were resuspended in 500 µl 0.1M Tris HCl (pH 7) and 20 µl of mutanolysin (5K U ml<sup>-1</sup>; Sigma), and incubated at 37°C overnight. Samples were boiled 5 min, and the insoluble fraction was separated by centrifugation at 13,000 x g for 2 min. The muropeptide-containing supernatants were lyophilized, and resuspended in 5 µl of a 0.2 M disodium 8-amino-1,3,6-naphthalenetrisulfonate (ANTS; Invitrogen) solution in 15% Acetic Acid (Fisher) and 5 µl of a 1 M sodium cyanoborohydride (Acros) solution in DMSO. The samples were incubated overnight at 37 °C, dried by centrifugal vacuum and resuspended in 200 µl loading buffer (62.5 mM Tris HCl pH 6.8, 20% glycerol). One micromole of carbohydrate standards of glucose (Sigma), maltose (Fisher), maltotriose (Acros), maltotetraose (MP Biomedicals), maltopentaose (Sigma) and maltohexaose (MP Biomedicals) were also ANTS-labeled and resuspended in 1 ml loading buffer. Labeled standards were combined to a final mixture of 1 nmol µl<sup>-1</sup> each.

Fluorophore-assisted carbohydrate electrophoresis (FACE) was performed in a Hoefer S600 gel apparatus. The 0.5 mm-thick acrylamide gels (18 cm x 16 cm) were composed of a stacking (8%

acrylamide, 0.2% bisacrylamide, 0.3 M Tris buffer pH 8.9) and running (32% polyacrylamide, 2.4% bisacrylamide, 0.3 M Tris buffer pH 8.9) gel component. Fifteen microliters of prepared samples were separated by electrophoresis at 4 °C for 2.5 hr, 35 mA in running buffer (0.192 M glycine, 25 mM Tris pH 8.9). The muropeptide bands were visualized by UV exposure (310 nm) and photographed using Cannon Powershot A650IS camera. Gels were analyzed for relative band intensity using Gel-Pro<sup>®</sup> Analyzer software (MediaCybernetics).

**Determination of peptidoglycan acetylation.** For quantification of peptidoglycan acetylation 30 mg of lyophilized cell wall preparations were resuspended in 1.5 ml 80 mM sodium hydroxide, and incubated at 37°C for 3 hr with shaking. The samples were ultracentrifuged (100,000 x g, 25°C) for 30 min to separate the insoluble wall fraction. The amount of released sodium acetate in the supernatant was assayed with the acetic acid (AK) kit (Megazyme) using a VersaMax microplate reader (Molecular Diagnostics). Standard curves were prepared from serial dilutions of sodium acetate (Sigma) for quantification.

## Results

**CpsY does not influence neutrophil phagosomal maturation.** Because CpsY is critical for intracellular survival in neutrophils, we sought to determine the mechanism behind this protective function. *S. pyogenes* has been shown to escape neutrophil phagocytic killing by inhibiting fusion of azurophilic granules with the maturing phagosome (269). To test whether CpsY functions to disrupt neutrophil phagosomal maturation in a similar manner, infected neutrophils were fixed and dual immunostained with antibodies against *S. iniae*, and either the secondary granule marker CD107A or azurophilic granule marker CD63. Laser confocal fluorescent microscopy images revealed that both WT and the  $\Delta cpsY$  mutant colocalize with secondary (Fig. 19A) and azurophilic granule markers (Fig. 19B), implying containment within a mature phagosome. The data suggest that *S. iniae* does not manipulate phagosomal maturation in neutrophils as observed for *S. pyogenes*. This also indicates that the protective function imparted by CpsY must occur within a mature neutrophil phagosome.

Though phagosomal maturation appears unaltered, CpsY may serve a protective role by regulating factors that in some way disrupt the microenvironment within a mature phagosome. To address this possible scenario, a 1:1 co-infection of neutrophils with WT *S. iniae* and the  $\Delta cpsY$  mutant was performed to determine if the CpsY protein produced in the WT strain could rescue the mutant strain when inhabiting the same phagosome. Co-infection of neutrophils had no effect on the  $\Delta cpsY$  mutant, resulting in significant killing compared to WT ( $p < 0.01$ ) and an extremely low competitive index of 0.06 (Fig 20). Furthermore, when neutrophil phagocytosis was inhibited by pretreatment with cytochalasin D (CD) or heat-inactivation of serum (HIS), growth of the  $\Delta cpsY$  mutant was restored to the levels observed in serum alone (Fig 20). Therefore, these results indicate that CpsY does not function to manipulate phagosomal maturation of neutrophils, but rather must regulate factors that provide direct protection to *S. iniae* from neutrophil killing mechanisms within a mature phagosome.

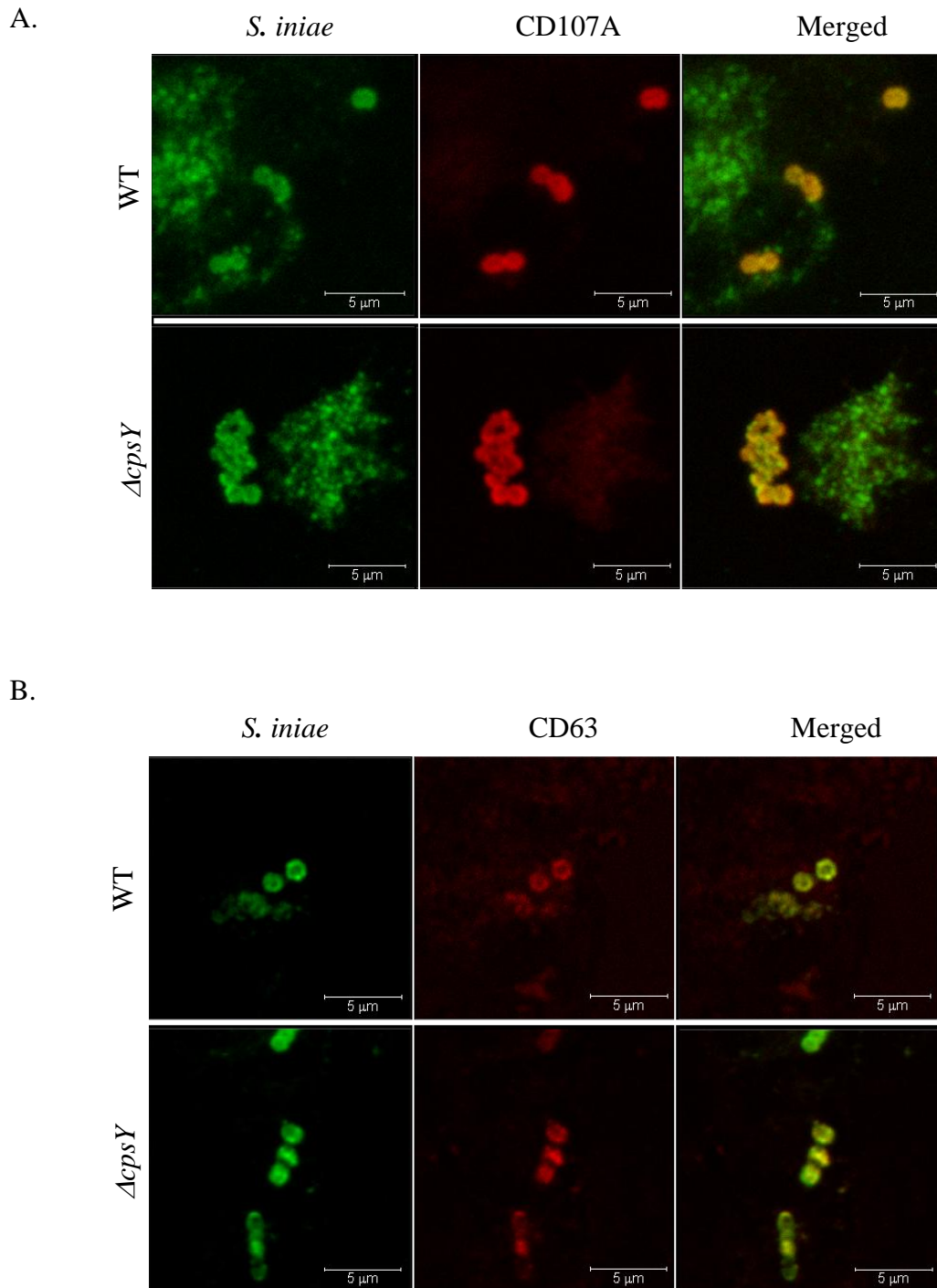


Figure 19. *S. iniae* colocalization with neutrophil granule markers CD107A and CD63. Infected Neutrophils were analyzed by confocal laser scanning fluorescence microscopy for localization of *S. iniae* WT or  $\Delta cpsY$  (green) in relation to the human neutrophil secondary granule marker CD107A (red) (A), or human neutrophil azurophil (primary) granule marker CD63 (red) (B). Shown is a maximum projection of a sequential scan

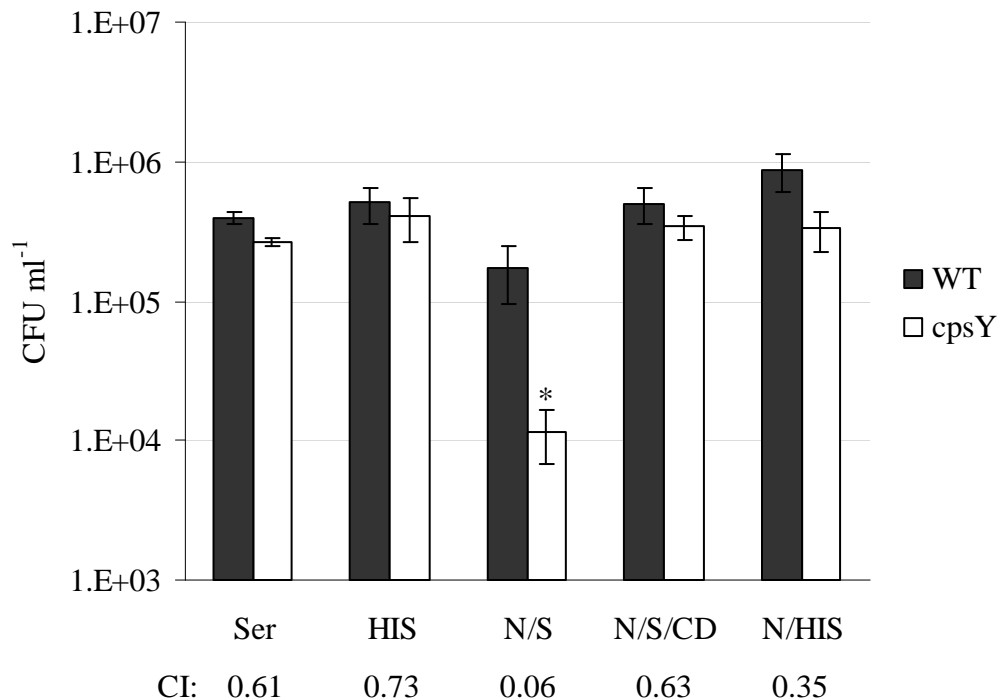


Figure 20. Neutrophil competition assay. Mid-logarithmic cultures of *S. iniae* WT (grey bars) and  $\Delta cpsY$  (white bars) were inoculated at a 1:1 ratio into 1 ml DMEM with 50% human serum (Ser) or 50 % heat-inactivated serum (HIS). Human neutrophils (N) were added at a ratio of 1000:1 (N:bacteria). If specified, neutrophils were pretreated with 10  $\mu\text{g ml}^{-1}$  cytochalasin D (CD) for 30 min to inhibit phagocytosis. Samples were incubated at 37 °C for 3 hr with gentle rotation, followed by serial dilution and replica plating on TP plates  $\pm$  1000  $\mu\text{g ml}^{-1}$  streptomycin for enumeration of bacterial CFU. The competitive index (CI) was determined as described in materials and methods. Error bars represent  $\pm$  standard error. \*  $p < 0.001$ .



**The  $\Delta cpsY$  mutant has increased lysozyme sensitivity.** Many of the bactericidal compounds contained within a mature neutrophil phagosome target components of the bacterial cell wall. The susceptibility of the  $\Delta cpsY$  mutant to neutrophil-mediated killing could imply that CpsY regulates factors involved in cell wall physiology. This could manifest as a decreased resistance to cell wall-targeting antibiotics or antimicrobial peptides. No differences in the minimal inhibitory concentration (MIC) were observed for the antibiotics colistin, gramicidin, carbenecillin, methicillin, teicoplanin, bacitracin, or the antimicrobial peptides nisin and LL-37 (Table 3). However, the  $\Delta cpsY$  mutant was significantly more sensitive to lysozyme with a 50% decrease in the MIC compared to WT (Table 3). The increased sensitivity of the  $\Delta cpsY$  mutant specifically to lysozyme suggests possible chemical alterations in the cell wall (21). In support of this, the  $\Delta cpsY$  mutant displayed an altered surface charge compared to the WT strain as determined by cytochrome *C* binding (Fig. 21). Taken together, the data provide evidence for CpsY in the regulation of factors involved in modification of the cell wall.

**Deletion of *cpsY* reduces peptidoglycan acetylation.** Lysozyme is an important component of epithelial secretions and phagocytic cells (34, 63, 66), and thus an obstacle necessary for pathogenic species to overcome. Lysozyme cleaves the  $\beta$ -(1,4)-glycosidic bonds between the *N*-acetylmuramyl (MurNAc) and *N*-acetylglucosamyl (GlcNAc) residues of peptidoglycan (PG). Chemical modifications of PG that increase lysozyme resistance include both the addition of *O*-linked acetyl groups to the MurNAc residues by the OatA acetyltransferase (20), or removal of *N*-linked acetyl groups of the GlcNAc residues by the PgdA deacetylase (299). Furthermore, the addition of wall teichoic acids and their D-alanylation have been shown to affect susceptibility to many of the antimicrobial peptides contained within neutrophil granules (235). To determine if CpsY influences the expression of genes involved in these processes, we performed quantitative PCR (qPCR) on both mid-logarithmic and stationary phase cultures of WT *S. iniae* and the  $\Delta cpsY$  mutant. Expression of a

Table 3. Minimal Inhibitory Concentration (mg ml<sup>-1</sup>)

	Colistin	Gramicidin	Carbencillin	Methicillin	Teichoplanin	Bacitracin	Nisin	LL-37 <sup>a</sup>	Lysozyme <sup>c</sup>
WT	250	0.0059	0.375	0.5	0.035	2.5	5	31.25	650000
<i>ΔcpsY</i>	250	0.0059	0.375	0.5	0.035	2.5	5	31.25	300000 <sup>c</sup>

*a.* Minimal Bactericidal Concentration

*b.* Active Enzymatic Units

*c.*  $p = 0.0003$

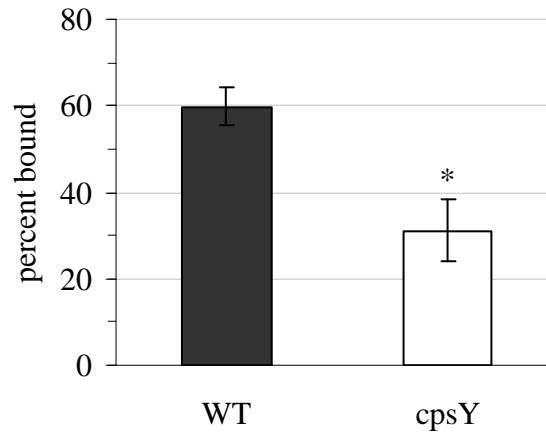


Figure 21. Measurement of bacterial cell surface charge. *S. iniae* WT or  $\Delta cpsY$  were normalized to an OD600 = 6.0, washed twice and resuspended in 20 mM MOPS buffer with 0.5 mg ml<sup>-1</sup> cytochrome *c* for 5 min. Samples were centrifuged and the OD540 of the supernatant was measured. The data represent percentage bound compared to input control. Error bars represent  $\pm$  standard error. \*  $p < 0.01$

putative PG *O*-acetyltransferase (*oatA*) was decreased > 2-fold in the  $\Delta$ *cpsY* mutant relative to WT (Table 4). No change in expression was observed for genes involved in teichoic acid biosynthesis (*tagO*), D-alanylation of teichoic acids (*dltA*) or PG *N*-deacetylation (*pgdA*).

To determine whether the decreased expression of *oatA* in the  $\Delta$ *cpsY* mutant was accompanied with an actual decrease in PG acetylation, purified PG preparations were treated briefly with 80 mM NaOH to release all *O*-linked acetyl groups (21). Quantification of released acetyl groups revealed > 20% decrease in the acetylation of PG from the  $\Delta$ *cpsY* mutant (Table 5). Thus the increased susceptibility of the  $\Delta$ *cpsY* mutant to lysozyme and intracellular killing by neutrophils may be due to an inability to properly acetylate the cell wall.

**The  $\Delta$ *cpsY* mutant contains altered muropeptide profiles.** The CpsY ortholog MtaR of *S. agalactiae* was previously shown to affect the expression of a diverse gene set (42). In an attempt to gain further insight into the *S. iniae* CpsY regulon, the microarray data obtained from that study was examined for differential expression of genes with probable effects on cell wall physiology. Relative expression of a gene encoding a putative *N*-acetylmuramoyl-L-alanine amidase (SAN\_0845) was found to be increased over 2-fold compared to WT. Analysis of the *S. iniae* ortholog (*murA*) by qPCR revealed the same 2-fold increased expression for the  $\Delta$ *cpsY* mutant relative to WT (Table 4). A mutant strain was accordingly designed to mimic the  $\Delta$ *cpsY* mutant by expressing MurA under the transcriptional control of a strong promoter within a WT background (10A63) in order to investigate whether overexpression of MurA was responsible for the observed phenotypes associated with the  $\Delta$ *cpsY* mutant.

*N*-acetylmuramoyl-L-alanine amidases (EC 3.5.1.28) breakdown PG muropeptides (single disaccharide of GlcNAc and MurNAc with a peptide component) by hydrolyzing the bond between the

**Table 4.** *S. iniae* qPCR results

Gene	Function	Pathway	Phase <sup>a</sup>	FC <sub>N</sub> <sup>b</sup>
<i>murA</i>	MurNAc-L-alanine amidase	Peptidoglycan recycling	ML	2.41 ± 0.13
			ST	2.04 ± 0.01
<i>oatA</i>	Putative O-acetyltransferase	Peptidoglycan acetylation	ML	0.43 ± 0.07
			ST	0.39 ± 0.05
<i>dltA</i>	D-alanine-poly(phosphoribitol) ligase	Teichoic Acid D-alanylation	ML	1.09 ± 0.12
			ST	1.09 ± 0.12
<i>pgdA</i>	Peptidoglycan GlcNAc deacetylase	Peptidoglycan deacetylation	ML	1.09 ± 0.15
			ST	1.37 ± 0.70
<i>tagO</i>	UDP-GlcNAc 1-P transferase	Teichoic Acid biosynthesis	ML	1.17 ± 0.18
			ST	0.95 ± 0.09

<sup>a</sup>Growth phase: mid-logarithmic (ML); stationary (ST).

<sup>b</sup>Relative fold change (*N*) gene expression for  $\Delta cpsY$  compared to WT ( $\Delta\Delta C_T$  method).

**Table 5.** Peptidoglycan acetylation

Strain	NaOAc concentration (pmol mg <sup>-1</sup> ) <sup>a</sup>
WT	300.58 ± 23.08
<i>ΔcpsY</i>	238.32 ± 10.16

<sup>a</sup> pmol of released sodium acetate per mg of purified peptidoglycan

muramoyl residue of the glycan backbone and the L-amino acid residue of the peptide side chain, a process required for cell division and PG recycling (245). An overproduction of these amidases could result in disruption of the muropeptide unit, resulting in an unstable cell wall and an increased susceptibility to neutrophil bactericidal killing mechanisms. To determine if overexpression of *murA* altered the muropeptide composition of the  $\Delta cpsY$  mutant, muropeptides were prepared by mutanolysin treatment of purified PG from WT *S. iniae*, the  $\Delta cpsY$  mutant and strain 10A63. These samples were then analyzed by fluorophore-assisted carbohydrate electrophoresis (FACE) (314), which allows for the differentiation of muropeptides based on their electrophoretic mobility profile. FACE analysis revealed that the relative concentration of soluble oligomeric muropeptide structures (crosslinked muropeptides) in the  $\Delta cpsY$  mutant was approximately half that of the WT strain (Table 6; M1-M5). This was accompanied by an increase in monomeric muropeptides (individual disaccharides of GlcNAc and MurNAc  $\pm$  peptides) (Table 6; M6-M7) and free MurNAc (M9) for the  $\Delta cpsY$  mutant. The 10A63 strain displayed some similarities to that of the  $\Delta cpsY$  mutant; however, the other differences were observed which differed from WT and the  $\Delta cpsY$  mutant. These results demonstrate that the overexpression of *murA* observed in the  $\Delta cpsY$  mutant may significantly alter the PG muropeptide profile; however, this is likely an additive effect in combination with other processes (i.e. decreased acetylation) because overexpression of *murA* alone (10A63) is not enough to mimic the muropeptide profile of the  $\Delta cpsY$  mutant. This alteration in the  $\Delta cpsY$  mutant could suggest a weakness in the stability of the cell wall, which could increase susceptibility of the  $\Delta cpsY$  mutant to neutrophil killing mechanisms.

**Individual complementation of the  $\Delta cpsY$  mutant does not rescue growth in vitro.**

Deletion of *cpsY* was previously shown to affect *S. iniae* growth patterns such that the  $\Delta cpsY$  mutant cultured in THY medium displayed a significant decrease in cell density upon entry into stationary phase (Fig. 5). In contrast, supplementing THY medium with 2% proteose peptone allowed the  $\Delta cpsY$

**Table 6.** Muropeptide percent composition<sup>a</sup>

Muropeptide	Compound <sup>b</sup>	WT	$\Delta cpsY$	10A63
M1	Multimeric MurNAc-peptides	6.61 ± 1.28	3.22 ± 0.99	4.37 ± 1.05
M2		3.29 ± 0.42	2.53 ± 1.11	3.14 ± 0.54
M3		3.94 ± 0.37	1.64 ± 0.69	3.94 ± 0.81
M4		15.47 ± 3.62	6.97 ± 2.75	12.99 ± 1.51
M5		7.47 ± 0.98	3.92 ± 1.35	6.52 ± 1.26
M6		5.76 ± 2.78	7.15 ± 5.98	0.30 ± 0.12
M7	MurNAc-peptide	39.71 ± 1.24	47.66 ± 3.17	47.70 ± 1.98
M8	GlcNAc	2.47 ± 0.68	2.31 ± 1.27	5.11 ± 1.29
M9	MurNAc	15.29 ± 3.19	24.59 ± 2.61	15.92 ± 1.75

<sup>a</sup> Determined by FACE analysis

<sup>b</sup> Muropeptide compound based on electrophoresis profile relative to known carbohydrate standards (314).



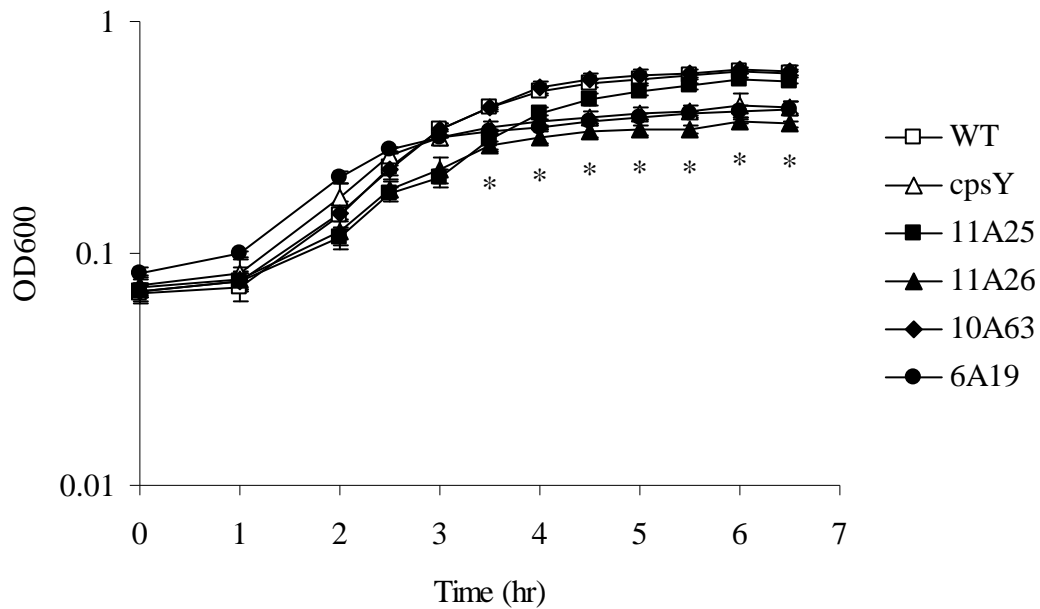
mutant to reach a final cell density significantly greater than WT (Fig. 5). As shown here, complementation of the  $\Delta cpsY$  mutant by expressing CpsY in trans (6A19) had a negligible effect on growth (Fig. 22). The inability for CpsY complementation suggests that normal CpsY-dependent regulation of effectors involved in growth is tightly controlled.

To determine whether a deficiency in OatA expression was the causative factor for aberrant growth of the  $\Delta cpsY$  mutant, strains were designed to circumvent the normal CpsY-dependent regulation by expressing OatA under transcriptional control of a strong promoter in the  $\Delta cpsY$  mutant (11A26) as well as a WT control (11A25). *S. iniae* WT, the  $\Delta cpsY$  mutant, and strains 11A25, 11A26 and 10A63 were then cultured in THY or THY supplemented with 2% proteose peptone (TP) and growth was monitored by measuring OD<sub>600</sub> every 30 min. Overexpressing OatA (11A26) did not rescue growth of the  $\Delta cpsY$  strain (Fig. 22). Rather, both 11A25 and 11A26 appeared to delay the start of exponential growth, and showed a significant decrease in cell density by stationary phase relative to their parent background (Fig. 22). Over expression of the *murA* gene in 10A63 resulted in no deviation from WT growth (Fig. 22). The data suggest that the aberrant growth of the  $\Delta cpsY$  mutant is a complex phenotype, which cannot be rescued or mimicked by individual complementation of CpsY-regulated genes.

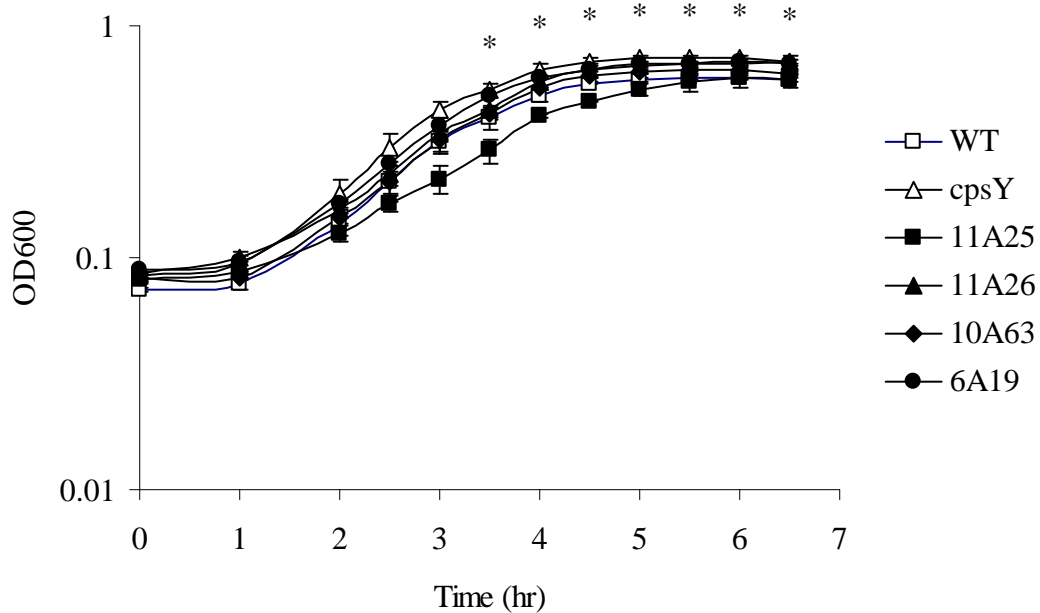
**Complementation of the  $\Delta cpsY$  mutant does not prevent killing in whole blood.** We sought to determine whether the altered expression of OatA or MurA in the  $\Delta cpsY$  mutant was directly responsible for the susceptibility to neutrophil-mediated killing in whole blood. *S. iniae* WT, the  $\Delta cpsY$  mutant, and strains 6A19, 10A63, 11A25 and 11A26 were incubated in whole blood for 3 hr at 37 °C and plated to determine bacterial survival. *S. iniae* WT and strains 11A25 and 10A63 constructed in a WT background were able survive in whole blood, whereas the  $\Delta cpsY$  mutant and strains 6A19 and 11A26 constructed in a  $\Delta cpsY$  background were completely killed (Fig. 23).

Pretreatment with CD rescued growth for all strains indicating that the observed attenuation was due to

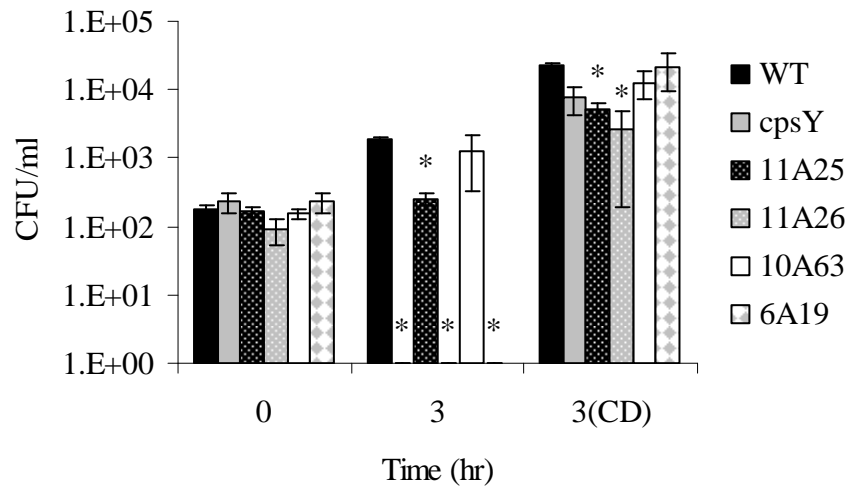
A.



B.



**Figure 22.** Bacterial growth curves. Overnight cultures were diluted 1:50 into 96-well plates containing 200  $\mu$ l of THY (A) or TP (B). Plates were incubated at 37  $^{\circ}$ C in 5% CO<sub>2</sub>, and OD<sub>600</sub> measurements were recorded over 6.5 hr. Error bars represent  $\pm$  standard error. \* $p < 0.05$  for all  $\Delta$ *cpsY* background strains ( $\Delta$ *cpsY*, 11A26, 6A19) compared to WT.

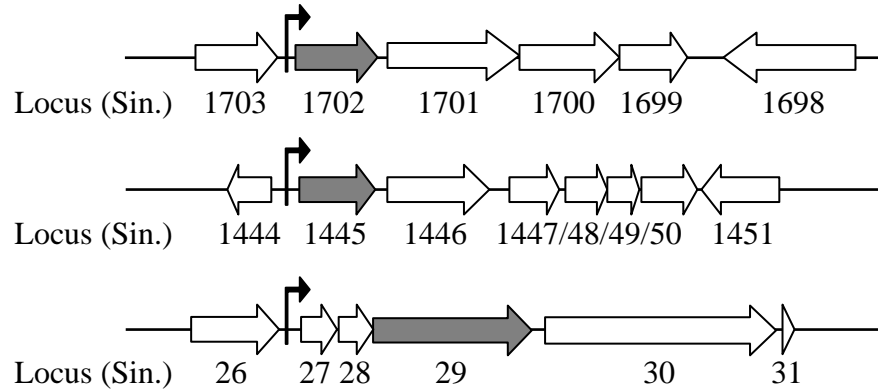


**Figure 23.** *S. iniae* survival in human whole blood. Mid-logarithmic phase cultures were diluted into 1 ml heparinized human whole blood, and incubated at 37 °C with gentle rotation. Samples were serially diluted and plated on THY for enumeration of bacterial CFU. For certain conditions blood was pretreated for 30 min with 10  $\mu\text{g ml}^{-1}$  CD to inhibit neutrophil phagocytosis. Error bars represent  $\pm$  standard error. \* $p < 0.05$ .

phagocytosis by neutrophils as previously described. To note, growth of 11A25 and 11A26 was significantly less than the respective parent strains ( $p < 0.01$ ), which correlates with the same growth restriction for both strains observed in THY medium (Fig. 22). Overall the data indicate that the protective effect of CpsY from neutrophil-mediated killing is through the tight regulation of multiple factors.

**Analysis of CpsY-regulated promoters.** Previous work has shown that certain genes under transcriptional control by Streptococcal orthologs of CpsY contain a highly conserved regulatory element termed Met box within their promoter region (158, 268). The presence of a Met box in the promoter region of a CpsY-regulated methionine ABC transport system (AtmBDE) suggests that this same element facilitates CpsY-dependent regulation in *S. iniae* as well (Fig. 7). We sought to determine if transcriptional regulation of *oatA* or *murA* by CpsY could be through this conserved element. The gene encoding OatA is predicted to be the 3<sup>rd</sup> gene of an operon (Fig 24A). Whether *murA* is part of an operon is unknown, but the predicted promoter is immediately upstream of *murA* (Fig. 24A). Analysis of the predicted promoter regions revealed the presence of a Met box within the *murA* promoter, but not the *oatA* operon promoter (Fig. 24B). Additionally, although the promoters of both *murA* and *atmB* contain the canonical Met box, a major structural difference exists for those regions. Twenty-two nucleotides separate the Met box and -35 site in the *atmB* promoter, whereas those elements are separated by 96 nucleotides in the *murA* promoter (Fig. 24B). This difference may explain why CpsY transcriptionally activates expression of *atmB* (Table 2) while repressing *murA* (Table 4). The absence of a Met box for *oatA* suggests the effect of CpsY on the expression of *oatA* may be indirect or occur in combination with additional factors.

A.



B.

Sin.1702-tatagtttaaaactata-n22-ttgata-n17-tagaat-n31-ATG  
 Sin.1445-tatagtttaaaactgta-n96-attata-n17-tataag-n54-ATG  
 Sin.0027-.....ttcatt-n17-tataat-n19-ATG

→                      ←  
 MetBox                      -35                      -10

Figure 24. Promoter alignment for CpsY-regulated genes. (A) Genetic locations of AtmBDE (Sin.1702-1699), MurA (Sin.1445) and OatA (Sin.29). (B) Predicted promote sequences obtained from GenBank were aligned and plotted using ClustalX. The predicted -10 and -35 sites are underlined, translational start codon is italicized, and predicted Met boxes are shaded.

## Discussion

Neutrophil phagocytosis of an opsonized pathogen is an intricate process whereby sequential maturation of the phagosome generates a highly bactericidal microenvironment (172, 256). Pathogens within the nascent phagosome are exposed to a burst of reactive oxygen species upon assembly of the NADPH oxidase. Phagosomal maturation ensues with successive fusion of pre-formed gelatinase, specific, and azurophilic granules that contain an arsenal of bactericidal compounds (256).

Engulfed microbes endure a multi-targeted attack within a mature phagosome. Transporters such as the natural resistance-associated macrophage protein 1 (Nramp1) (135) and chelating agents like neutrophil gelatinase-associated lipocalin (NGAL) (154) and lactoferrin (217) deprive microorganisms of vital metals such as iron, manganese, and zinc. Bacterial lipid membranes are the target of cytotoxic pore-forming antimicrobial peptides such as cathelicidins (241) and defensins (104) with bactericidal activity against both Gram negative and Gram positive bacteria. Furthermore, myeloperoxidase can react with hydrogen peroxide to generate hypochlorous acid (HOCl), tyrosine radicals and reactive nitrogen intermediates, all of which can attack the surface membranes of microorganisms (155). Engulfed pathogens are also exposed to serprocidins (serine proteases with microbicidal activity) like proteinase-3, cathepsin G and elastase (48, 250, 264), as well as lysozyme, which has both muramidase-dependent and independent antimicrobial activity (211).

Bacterial pathogens employ 3 characterized strategies for intracellular survival in neutrophils: inhibition of phagosomal maturation, survival within a mature phagosome, or escape into the cytoplasm (289). *S. pyogenes* evades intracellular neutrophil killing by inhibiting phagosomal maturation through an uncharacterized mechanism involving M protein (269). In contrast, we demonstrate that phagosomal maturation is unaltered in *S. iniae*-infected neutrophils, as determined by co-localization with both azurophilic and specific granules. Thus the high degree of attenuation observed for the  $\Delta cpsY$  mutant upon phagocytosis must be due to the dysregulation of specific factors

required for survival within a mature phagosome. These CpsY-regulated factors must be acting directly on the bacteria rather than manipulating the phagosomal microenvironment due to the inability of WT *S. iniae* to rescue the  $\Delta cpsY$  mutant during co-infection of neutrophils.

Protection from the bactericidal components encountered within a mature neutrophil phagosome begins in part with sensory input from a variety of two-component systems (TCS), resulting in the activation of cell stress response and wall modification programs (160, 173, 233, 240, 279, 294). These systems can activate enzymes that allow the bacteria to decorate both the cell membrane and cell wall with various chemical modifications. For example, lipid lysinylation of the cellular membrane by MprF (92, 162, 225, 283) (251) and D-alanylation of wall teichoic acids by the DltABC locus (55, 100, 157, 159, 161, 235) provide protection from cationic antimicrobial peptides. Resistance to lysozyme occurs through PG acetylation of MurNAc residues by the OatA *O*-acetyltransferase found in Gram positive organisms (20-21, 68, 126, 294) or the PatA/PatB system in Gram negative organisms (206). Additionally the PgdA *N*-deacetylase mediates lysozyme resistance through deacetylation of PG GluNAc residues (32, 199, 298-299, 301). The significant increase in lysozyme sensitivity of the  $\Delta cpsY$  mutant without a concomitant change in sensitivity to  $\beta$ -lactam antibiotics or antimicrobial peptides tested suggests possible specific chemical modifications to PG such as *O*-acetylation or *N*-deacetylation. The decrease in *oatA* expression for the  $\Delta cpsY$  mutant with a concomitant reduction in total PG acetylation suggest that susceptibility to neutrophil-mediated killing may be due to the inability to properly acetylate the cell wall.

The OatA *O*-acetyltransferase was originally identified in pathogenic staphylococci (20-21), and homologs have been described for *Streptococcus pneumoniae* (68), *Enterococcus faecalis* (121) and *Lactococcus lactis* (294). OatA is a membrane spanning protein thought to utilize cytoplasmic acetyl-CoA as a donor for the translocation of acetate to the C6 hydroxyl group of MurNAc residues in the murein sacculus (166). In *L. lactis* the CesSR TCS responds to lysozyme-induced cell envelope

stress by activation of OatA through the intermediate SpxB regulator (294). CesSR homologs have also been shown to respond to cell envelope stress for *S. pneumoniae* (91, 114), *S. mutans* (279), *S. aureus* (164), *B. licheniformis* (302) and *B. subtilis* (139). *S. iniae* also contains a CesSR homolog; however, its functionality in cell envelope stress response is unknown. Whether the reduced PG acetylation observed for the  $\Delta cpsY$  mutant is influenced by the CesSR stress response pathway is yet to be determined. The observed reduction in PG acetylation of the  $\Delta cpsY$  mutant could alternatively represent an inability to accumulate acetylated PG through exponential growth into stationary phase rather than an effect of stress response (166, 226). The absence of a Met box in the predicted *oatA* promoter suggests an indirect effect by CpsY. Attempts to complement the  $\Delta cpsY$  mutant through overexpression of OatA were unsuccessful, resulting in slight growth retardation and continued susceptibility to neutrophil-mediated killing in whole blood. Similar observations have been made for PG hyperacetylation in *L. lactis* (294) and *Lactobacillus planeterum* (24), suggesting that tight regulation of the *O*-acetyltransferase is necessary for optimal growth.

The observed decrease in PG acetylation for the  $\Delta cpsY$  mutant could result in an increased sensitivity to the cell's own autolysins (29, 224). These PG hydrolases encompass several distinct enzymes including the *N*-acetylmuramidases, *N*-acetylglucosaminidases, *N*-acetylmuramyl-L-alanine amidases and lytic transglycosylases, all of which perform specific enzymatic functions necessary for cell wall growth, turnover and separation during cellular division (245). The strict spatial and temporal control of these enzymes is critical for prevention of unregulated PG hydrolysis (286). PG *O*-acetylation can inhibit certain autolysins such as lytic transglycosylases (29, 224), whereas others such as the *N*-acetylmuramyl-L-alanine amidases are unaffected (28, 226). As shown here, CpsY acts as a transcriptional repressor of a putative *N*-acetylmuramoyl-L-alanine amidase (MurA), presumably through interactions with the conserved Met box in the MurA promoter. *N*-acetylmuramoyl-L-alanine amidases play an important role in separation during cell division (51, 106, 124, 166, 237), and can be



potent autolysins when overexpressed (124-125). The increased expression of *murA* along with decreased PG acetylation could render the  $\Delta cpsY$  mutant susceptible to detrimental restructuring of the murein sacculus, thereby increasing the sensitivity to many of the bactericidal factors contained within a neutrophil phagosome. FACE analysis revealed a reduction in the proportion of oligomeric muropeptide structures (crosslinked soluble muropeptides) for the  $\Delta cpsY$  mutant with a concomitant increase in single muropeptides and free MurNAc and GluNAc residues, indicative of an altered cell wall. Overexpression of MurA alone in WT *S. iniae* (10A63) did not produce the same muropeptide profile observed for the  $\Delta cpsY$  mutant, and resulted in little difference from WT for growth or susceptibility to killing in whole blood. Thus simply overexpression of MurA, perhaps without an accompanying decrease in PG acetylation, does not explain the susceptibility to neutrophil-mediated killing observed for the  $\Delta cpsY$  mutant.

CpsY is orthologous to the MetR regulator of methionine metabolism and uptake pathways in Gram positive and Gram negative bacteria. MetR was originally characterized for its regulation of methionine supply through activation of both the cobalamin-independent methionine synthase (MetE)/5,10-methylenetetrahydrofolate reductase (MetF) for conversion of homocysteine to methionine, as well as a methionine ABC transport system (AtmBDE) (268). *S. iniae* does not possess the genes encoding MetE or MetF, but CpsY does function as a transcriptional activator of AtmBDE. MetR mutants of *S. mutans* and *S. agalactiae* display a growth defect in serum, which can be rescued in the presence of exogenous methionine (42, 259, 268). In contrast, the serum growth defect of the *S. iniae*  $\Delta cpsY$  mutant was shown to be independent of methionine. Rather, the  $\Delta cpsY$  mutant displayed aberrant growth patterns in which the final cell density reached levels significantly greater or less than WT dependent upon the culture medium. This suggests that the CpsY regulon may act on processes involved in cell growth and division rather than simply methionine uptake and metabolism.

Furthermore this likely involves multiple elements as attempts to individually complement CpsY-regulated genes were unsuccessful in restoring WT growth.

In *E. coli* cellular growth and division was recently shown to be strongly influenced by the supply of both *S*-adenosylmethionine (SAM) and an undefined single-carbon (C<sub>1</sub>) tetrahydrofolate (THF) derivative (317). Zhang *et al.* observed that a mutant strain of *E. coli* lacking all L-serine deaminases was unable to control cellular division resulting in long chains of cells with abnormal bulging morphologies when cultured in medium containing 0.5% casamino acids (CAA) (317). Supplementing the medium with exogenous SAM partially restored the mutant to the natural rod-shaped morphology of WT *E. coli*; however, the cells were still unable to properly separate during division resulting in extended chains of long narrow cells. Moreover, overexpression of the glycine cleavage operon (GCV), which breaks down glycine for synthesis of 5,10-methyleneTHF, in the serine deaminase mutant fully restored WT cell morphology when cultured in the CAA medium.

A supply of C<sub>1</sub>-THF derivatives such as 5,10-methyleneTHF is required for the synthesis of methionine, which is then converted to SAM by the *S*-adenosylmethionine synthase (Fig. 1). Thus mutations which disrupt either the supply of methionine or C<sub>1</sub>-THF derivatives ultimately limit the production of SAM. Normally the both the GlyA serine hydroxymethyltransferase and GCV act to increase cytoplasmic pools of 5,10-methyleneTHF through breakdown of serine and glycine respectively. The buildup excess of cytoplasmic glycine caused by growth in a complex amino acid mixture such as CAA can result in the inhibition GlyA. The resultant accumulation of serine can then act to inhibit the GCV, which is then unable to breakdown glycine and the inhibition is exacerbated (317). Normally cellular serine deaminases decrease cytoplasmic serine pools to a stable level so as to limit this inhibitory cycle; however, in the *E. coli* serine deaminase mutant this inhibition could not be relieved. Thus the mutant strain became starved for C<sub>1</sub>-metabolites due to the inability to generate THF derivatives through the breakdown of serine and glycine. The ability of exogenous SAM to limit the bulging cell morphology of the serine deaminase mutant indicates a possible role for SAM in cell

wall physiology; however, the ability of GCV overexpression to fully restore WT cellular morphology suggests that an additional process influenced by C<sub>1</sub>-THF derivatives is ultimately involved in cell division. Thus proper cell growth and division appears to depend on the metabolic state of the cell, and both C<sub>1</sub>-THF and SAM may be needed for activation of the cell division machinery (317).

Intriguingly, MetR is also a transcriptional activator of GlyA in *E. coli* (65). A MetR-dependent increase in GlyA production would increase the cytoplasmic pool of C<sub>1</sub>-THF derivatives. Thus MetR functions to increase production of C<sub>1</sub>-THF derivatives through transcriptional activation of GlyA, as well as activation of methionine synthesis and uptake pathways for generation of SAM, both of which are required for proper cell division. Whether SAM and C<sub>1</sub>-THF derivatives are required for cellular division in *S. iniae* is unknown. In addition, CpsY-dependent regulation of GlyA expression has not been investigated; however, a canonical Met box exists among streptococcal species in the predicted promoter region of a gene encoding a 5,10-methylenetetrahydrofolate dehydrogenase (FolD) (Fig. 1) (158), suggesting that that CpsY does regulate C<sub>1</sub>-THF metabolic processes for streptococcal species as well. Whether disruption of these processes accounts for the growth phenotypes and virulence attenuation of the  $\Delta cpsY$  mutant remains to be determined.

Methylation reactions involving SAM result in the production of intermediates such as *S*-adenosylhomocysteine (SAH) and *S*-ribosylhomocysteine (SRH), which are recycled back to homocysteine by the methylthioadenosine nucleosidase (Pfs) and *S*-ribosylhomocysteinase (LuxS) (Fig. 6). Mutations of LuxS result in the inability to properly recycle SAH and SRH, and the concomitant buildup of SAH in a LuxS mutant can inhibit many SAM-dependent methyltransferases (257). Recently it was observed that LuxS mediates protection of *S. pneumoniae* from autolysis by the major LytA autolysin, an *N*-acetylmuramyl-L-alanine amidase (17), through an unknown mechanism (249). Whether the LytA-dependent autolytic phenotype in the LuxS mutant was the result of a direct deregulation of LytA or an SAH-mediated inhibition of cellular methyltransferases was not

determined. This work does however provide evidence for a link between processes involving both SAM and autolysis in streptococci. Because CpsY influences both of these processes through activation of methionine supply pathways which ultimately lead to synthesis of SAM, and direct repression of an *N*-acetylmuramyl-L-alanine amidase, the observed growth phenotypes and virulence attenuation of the  $\Delta cpsY$  mutant could be due to the inability to properly regulate autolysis.

Protection from LytA-dependent autolysis has also been linked to the CiaRH TCS (111, 205). Furthermore, the simultaneous mutation of both *ciaRH* and *luxS* has an additive autolytic effect in *S. pneumoniae* (249). Pneumococcal CiaRH directly influences transcription at 15 promoters, 5 of which regulate production of small RNAs involved in the control of stationary-phase autolysis (115). CiaRH has also been shown to play a role in *S. agalactiae* lysozyme resistance and protection from neutrophil-mediated killing (240). Whether the CiaRH TCS of *S. iniae* also functions to protect the cell from autolysis has yet to be determined. Furthermore it is unknown whether CpsY has a regulatory role in the expression of CiaRH or vice versa. Ultimately it appears that the relationship between SAM and control of cellular autolysis is extremely complex and multifaceted, but could have considerable influence on cell wall physiology and virulence.

A delicate balance exists in which SAM and C<sub>1</sub> derivatives influence both cellular autolysins and division machinery. These processes are tightly controlled, and dysregulation has considerable implications on growth and virulence. CpsY could influence this balance by increasing AtmBDE and GlyA production for the generation of SAM and C<sub>1</sub> derivatives respectively, while at the same time repressing the expression of cellular autolysins (i.e. MurA). The inability to complement the  $\Delta cpsY$  mutation reflects this pleiotropic function. CpsY is a complex transcriptional regulator, and the high degree of conservation is indicative of its critical importance for basic processes of all prokaryotic microorganisms. Variations in the CpsY regulon, however, can manifest as a diversity of species-specific phenotypes, and likely represent environmental niche adaptations. Many different metabolic

pathways converge on cell division and PG biosynthesis, and mutants in components of these pathways often share similar virulence phenotypes. For example, *S. iniae* mutants of phosphoglucomutase (PgmA) (44) and *S. mutans* mutants of phosphoglucosamine mutase (GlmM) (311) also display similar increases in lysozyme sensitivity, susceptibility to neutrophil-mediated killing and virulence attenuation in vivo. The common attenuation observed upon mutations within these converging pathways suggests that combinational therapies targeting these basic processes would be a powerful treatment strategy.

## CHAPTER 4

### General Conclusions

Invasive streptococcal disease remains a global health concern that has been exacerbated by difficulties in vaccine design and emerging unprotected strains. The use of alternative models to investigate invasive streptococcal disease may provide a necessary understanding of the detailed mechanisms behind streptococcal infections. We describe here the use of *Streptococcus iniae* as a model organism to investigate the role of a conserved transcriptional regulator, CpsY, in invasive disease. CpsY is orthologous to the ubiquitous MetR transcriptional regulator found in Gram negative and Gram positive bacteria. A primary function of MetR is to increase transcription of the genes encoding the cobalamin-independent (MetE) and cobalamin-dependent (MetH) methionine synthase and 5,10-methyleneTHF reductase (MetF) for biosynthesis of methionine from homocysteine. In Gram negative bacteria MetR also increases expression of the GlyA serine hydroxymethyltransferase to increase synthesis of 5,10-methyleneTHF (60), the required methyl donor for the conversion of homocysteine to methionine by MetE and MetH. In Gram positive bacteria, MetR regulation of GlyA has never been shown, but MetR does have moderate transcriptional control of the genes encoding an ABC methionine transport system, AtmBDE (MetQ1NP). Thus, a general function of MetR is to increase cellular methionine pools through transcriptional activation of de-novo biosynthetic and transport machinery.

In Gram negative bacteria, a second level of transcriptional control of methionine synthesis and transport processes involves the MetJ:SAM repressor complex. When SAM levels are high, indicative of a sufficient methionine pool, MetJ utilizes SAM as a cofactor to bind to the Gram negative Metbox within the promoter regions of most genes involved in the synthesis of methionine as well as *glyA* encoding a serine hydroxymethyltransferase. When SAM levels drop, indicative of a shrinking methionine pool, this repression is relieved, allowing the bacteria to quickly respond to decreasing

SAM levels as a trigger to increase methionine biosynthesis before cellular methionine concentrations drop to a critical level, which could effect translational processes. This also includes derepression of the genes encoding the methionine transporter (*AtmBDE*) to import extracellular methionine, although multiple transport systems are thought to have methionine transport capability (103, 143). There are no known homologs of MetJ in Gram positive organisms.

In *Streptococcus mutans*, mutants of *metR* display a severe growth defect in a chemically defined medium lacking methionine (268). The growth defect is due to the inability to properly express the *metEF* genes for de-novo synthesis of methionine. This growth defect can be rescued to WT levels with a sufficient supply of exogenous methionine. In *S. mutans*, MetR has substantially greater transcriptional control over *metEF* than *atmBDE* (30-fold vs. 3 fold respectively) under methionine limitation, or with sufficient methionine in the presence of excess homocysteine, suggesting that a primary function of MetR is to regulate de novo synthesis of methionine rather than environmental scavenging. In *Streptococcus agalactiae*, mutants of *mtaR* (*metR*) also display a significant growth defect in chemically defined medium in the absence of methionine, and as with *S. mutans* growth is rescued when the medium is supplemented with methionine (259). Unlike *S. mutans*, MtaR control of MetEF and AtmBDE expression has not been studied under methionine limitation. In the presence of sufficient methionine, MtaR is a transcriptional activator of *atmBDE* but not *metEF* (42). This transcriptional activation of *atmBDE* in the presence of methionine is opposite to the expression profile observed in *S. mutans* (268) suggestive of altered MtaR regulatory function. Though *S. agalactiae* contains MetEF for synthesis of methionine from homocysteine as well as the genes for the recycling of SAM to homocysteine, it lacks genes required for the biosynthesis of homocysteine from cysteine. Thus the altered transcriptional control observed for the genes encoding the AtmBDE transporter may be reflective of this difference. Understanding MtaR regulation in *S. agalactiae* under methionine limitation, especially of MetEF, would be of significant value.

A small subset of streptococcal pathogens, including *S. iniae* and *S. pyogenes*, lack the genes encoding MetEF, but do contain homologs of the AtmBDE transporter. Kovaleva and Gelfand have proposed that for these auxotrophs methionine must be obtained through extracellular scavenging and peptide recycling (158). As with *S. mutans* and *S. agalactiae* a significant growth defect was observed in either serum or THY medium for the *S. iniae*  $\Delta cpsY$  mutant; however, this was unable to be rescued with exogenous methionine. This growth defect was not the result of a significant difference in the logarithmic growth rate but rather represented an early entry into stationary phase growth resulting in decreased final cell density. Whereas the  $\Delta cpsY$  mutant displays a significant methionine-independent growth defect in serum or THY medium, growth in C-medium was equivalent to WT ( $\pm$  methionine), suggesting that the effect of CpsY in *S. iniae* is not solely to regulate methionine acquisition. If this were the case one would expect a similar growth defect in C-medium as observed in THY. Moreover, the ability to induce significant growth of the  $\Delta cpsY$  mutant in excess of WT by supplementing either THY or C-medium with 2% proteose peptone suggests that the  $\Delta cpsY$  mutant is unable to properly control logarithmic growth and entry into stationary phase dependent upon environmental conditions.

CpsY regulation of the genes encoding the AtmBDE methionine transporter was shown to occur in the presence but not absence of methionine as observed for *S. agalactiae*. Moreover, the addition of exogenous homocysteine has no significant effect on this regulation in contrast to *S. mutans*. Additionally, when grown in THY medium supplemented with proteose peptone, CpsY appears to act as a transcriptional repressor of *atmBDE*. CpsY orthologs have been shown to regulate effector targets through the conserved Metbox. No observable differences were found in the genetic location of a Metbox in the *atmBDE* promoter, which suggests that the drastic differences in transcriptional regulation observed under varying environmental conditions is due to additional regulation at that site.



Thus, although MetR orthologous mutants of *S. mutans* and *S. agalactiae* share a methionine-dependent growth defect in chemically defined medium, MetR regulation of *atmBDE* is inhibited in the presence of methionine for *S. mutans* but activated for *S. agalactiae* and *S. iniae*. Moreover, though CpsY of *S. iniae* shares similar transcriptional regulation of *atmBDE* as *S. agalactiae*, the growth defect of the  $\Delta$ *cpsY* mutant cannot be rescued with exogenous methionine. Because *S. iniae* is purely auxotrophic due to the absence of MetEF, it is likely that there are other mechanisms for obtaining methionine as proposed for Gram negative bacteria and suggests that the growth effects observed for the  $\Delta$ *cpsY* mutant are due to a dysregulation of other factors. Moreover, the data highlight major differences in the streptococcal methionine supply pathways, suggesting that greater variability in methionine acquisition may exist than previously recognized.

Disregulation of growth as observed for the  $\Delta$ *cpsY* mutant in response to peptone supplementation could indicate a function for CpsY in either the RelA-dependent stringent response or the RelA-independent stress response pathways, which are responsible for coordinating cellular division and entry into stationary phase growth in response to amino acid starvation. The RelA-dependent stringent response pathway is a cellular stress response to amino acid starvation that has widespread effects on growth and virulence (74). A decrease in cellular amino acids results in a shift in the ratio of uncharged to charged tRNAs. RelA is associated with ribosomes and is activated by the presence of uncharged tRNAs in the ribosomal A site. Activation of RelA triggers its own synthetase activity for synthesis of guanosine 3',5'-bispyrophosphate (ppGpp). Levels of ppGpp are also controlled by SpoT. SpoT has both a basal ppGpp hydrolase activity and inducible synthetase activity dependent upon cellular starvation of carbon sources, fatty acids, phosphates, iron and energy depletion. Together RelA/SpoT are responsible for any accumulation of ppGpp in the cell. The synthesized ppGpp can bind to the  $\beta$ -subunit of RNA polymerase to affect promoter specificity and facilitates outcompetition of the RpoS sigma factor with the housekeeping  $\sigma^{70}$ . Activation of the

stringent response results in a decrease in rRNA biosynthesis, ribosomal proteins and DNA replication with a concomitant increase in RpoS, stress proteins and amino acid biosynthesis machinery all of which have major implication on bacterial growth and division and help coordinate entry into stationary phase growth.

Where RelA-dependent responses allow the cell to shut down energy intensive metabolic processes in response to nutrient starvation, RelA-independent systems also respond to nutrient limitation to initiate several systems involved in nutrient acquisition (272). The transcriptional regulator CodY binds both branched chain amino acids (BCAA) and GTP as cofactors, and inhibits expression of many genes associated with adaptive responses to poor growth conditions including stationary phase adaptation, virulence and nutrient stress (266). CodY normally represses these genes during exponential growth, and induces them when the cell encounters nutrient limitation as the growth rate diminishes. As cellular amino acid concentrations diminish, RelA reduces GTP pools by synthesizing ppGpp. The reduction of both GTP and BCAA results in derepression of CodY-regulated genes. CodY-regulated genes derepressed under amino acid starvation include the oligopeptide permease (*opp*), intracellular peptidase (*pepB*), *covRS*, virulence associated *fas* operon, streptolysin S operon, *luxS* and *ropB* which results in activation of the SpeB extracellular protease. Many of these genes encode virulence factors which result in the destruction of host cells and tissues. This destruction most likely releases various peptides and nucleotides, which are then scavenged and recycled by the cell for nutrients. CodY and RelA don't regulate each other, and thus appear to influence the expression of separate, but complimentary, nutrient stress response programs in response to decreasing amino acid supplies (192).

The specifics as to how CpsY could function as part of RelA-dependent or independent response pathways is unclear. Kang *et al.* (145) recently described an additional arm of the RelA-independent amino acid response pathway involving CvfA, a general RNase that regulates virulence gene expression in response to nutrient stress and cellular growth phase. CvfA couples with the

glycolytic enzyme enolase to direct degradation of transcripts associated with various aspects of cell transport, metabolism and energy production, and increase the expression of virulence factors such as SpeB, SLS and the mitogenic factor, an extracellular DNase. Previously, comparison of protein extracts from *S. iniae* WT and the  $\Delta cpsY$  mutant revealed an increase in the level of enolase as determined by mass spectrometry analysis (201). Though it is unknown if CpsY directly regulates expression of enolase, the increased enolase levels in the  $\Delta cpsY$  mutant could have significant effects on these types of stress response pathways. Additionally, the *B. subtilis* CvfA homolog, YmdA, drastically affects transcript stability such that mutants of *ymdA* display over 2-fold increase in the half life of cellular mRNA (64). Although not specifically measured, noticeably more total RNA was routinely isolated from the  $\Delta cpsY$  mutant compared to WT *S. iniae*. This could also indicate an influence on a similar pathway involving transcript stability.

A common theme gaining acceptance in the literature is that mutations which limit the ability of streptococci to respond to nutritional stress result in a severe attenuation in vivo (148-149). The association of CpsY and its orthologs with methionine biosynthesis and uptake pathways suggests that this may also be true for the  $\Delta cpsY$  mutant. Mutation of *cpsY* had significant effects on *S. iniae* virulence due to an increased susceptibility to neutrophil-mediated killing in whole blood. This attenuation in whole blood may explain the significant decrease in CNS invasion previously described for the  $\Delta cpsY$  mutant (185), because the inability for maintaining a significant level of bacteremia is considered an important prerequisite for invasion through the vascular endothelial barriers of the brain (43, 84, 240, 318). The susceptibility of the  $\Delta cpsY$  mutant to neutrophil-mediated killing likely reflects an inability to properly modify the cell wall, which leads to an increased sensitivity to lysozyme and other neutrophil microbicidal compounds. This increased lysozyme sensitivity may be due in part to the inability to properly acetylate PG, as indicated by decreased expression of *oatA* and reduction in acetylated PG. The disruption of PG acetylation must be tightly controlled, however, since

overexpression of *oatA* results in growth retardation. The specifics as to how CpsY influences these properties are still unclear. The lack of a proper Metbox in the predicted *oatA* promoter region is suggestive of an indirect effect by CpsY, but the possibility of weak interactions at the promoter cannot be discounted.

CpsY also appears to directly limit the expression of a major autolysin. Limiting expression of a cell wall autolysin could promote stability of the cell especially in times of environmental stress such as that found within mature neutrophil phagosomes. Attempts to replicate phenotypes of the  $\Delta cpsY$  mutant through overexpression of the autolysin in WT *S. iniae* were unsuccessful indicating that any detrimental effect of overexpressing the autolysin exists only when coupled with other alterations occurring in the  $\Delta cpsY$  mutant. CpsY-coordinated actions which limit the expression of cell wall recycling machinery (i.e. MurA) and increase the ability to protect against wall degrading antimicrobial factors (i.e. OatA) could represent an important piece of a stress response pathway for survival in vivo. The inability to complement the  $\Delta cpsY$  mutant suggests that the regulation imparted by CpsY is multifaceted and represents tightly controlled adaptive changes.

As discussed in chapter 3, a delicate balance exists in terms of how pathways integrated with metabolites such as SAM or C<sub>1</sub>-THF derivatives influence both cellular autolysins (249) and division machinery (317). However, the ineffectiveness of exogenous methionine in rescuing the  $\Delta cpsY$  mutant suggests that the high degree of attenuation is not due strictly to disruption in the regulation of methionine supply pathways contributing to cytoplasmic pools of SAM. The effect of adding exogenous SAM to cultures of the  $\Delta cpsY$  mutant was never tested and would be of interest; however no CpsY-dependent effect on the expression or activity of MetK has ever been observed, and in the experiments where exogenous methionine was added it is likely that the methionine would be converted to SAM if necessary for the cell.

The complexity observed with mutation of CpsY in *S. iniae* suggests that this transcriptional regulator maintains tight control over multiple processes. This would make CpsY a good mark for targeted antimicrobial therapies, for example with small molecule inhibitors. Furthermore, utilizing *S. iniae* to study the regulatory role of CpsY provides a unique system for understanding the complex adaptive responses of invasive pathogens to the various stresses imparted by the host. Streptococcal pathogens appear to be able to coordinate nutritional stress responses by upregulation of virulence factors to acquire nutrients from the host, while at the same time limiting their own destruction by modifying their cell wall to protect against self autolysins and host antimicrobial defenses. While many of the specific details within these complex and highly integrated stress response pathways remain to be elucidated, their high degree of conservation among prokaryotes, and the severe loss of pathogenicity upon their disruption would indicate these as good therapeutic targets.

## REFERENCES

1. 2010. Licensure of a 13-valent pneumococcal conjugate vaccine (PCV13) and recommendations for use among children - Advisory Committee on Immunization Practices (ACIP), 2010. MMWR Morb Mortal Wkly Rep **59**:258-261.
2. 2010. Recommendations for the prevention of *Streptococcus pneumoniae* infections in infants and children: use of 13-valent pneumococcal conjugate vaccine (PCV13) and pneumococcal polysaccharide vaccine (PPSV23). *Pediatrics* **126**:186-190.
3. **Abranches, J., M. M. Nascimento, L. Zeng, C. M. Browngardt, Z. T. Wen, M. F. Rivera, and R. A. Burne.** 2008. CcpA regulates central metabolism and virulence gene expression in *Streptococcus mutans*. *J. Bacteriol.* **190**:2340-2349.
4. **Agnew, W., and A. C. Barnes.** 2007. *Streptococcus iniae*: an aquatic pathogen of global veterinary significance and a challenging candidate for reliable vaccination. *Vet. Microbiol.* **122**:1-15.
5. **Amsterdam, A., and T. S. Becker.** 2005. Transgenes as screening tools to probe and manipulate the zebrafish genome. *Dev Dyn* **234**:255-268.
6. **Amsterdam, A., and N. Hopkins.** 2006. Mutagenesis strategies in zebrafish for identifying genes involved in development and disease. *Trends Genet* **22**:473-478.
7. **Bachrach, G., A. Zlotkin, A. Hurvitz, D. L. Evans, and A. Eldar.** 2001. Recovery of *Streptococcus iniae* from diseased fish previously vaccinated with a streptococcus vaccine. *Appl Environ Microbiol* **67**:3756-3758.
8. **Baiano, J. C., R. A. Tumbol, A. Umapathy, and A. C. Barnes.** 2008. Identification and molecular characterisation of a fibrinogen binding protein from *Streptococcus iniae*. *BMC Microbiol* **8**:67.

9. **Baiano, J. C. F., and A. C. Barnes.** 2009. Towards control of *Streptococcus iniae*. *Emerg. Infect. Dis.* **15**:1891-1896.
10. **Baird, R. W., M. S. Bronze, W. Kraus, H. R. Hill, L. G. Veasey, and J. B. Dale.** 1991. Epitopes of group A streptococcal M protein shared with antigens of articular cartilage and synovium. *J. Immunol.* **146**:3132-3137.
11. **Baker, C. J., L. C. Paoletti, M. A. Rench, H. K. Guttormsen, V. J. Carey, M. E. Hickman, and D. L. Kasper.** 2000. Use of capsular polysaccharide-tetanus toxoid conjugate vaccine for type II group B *Streptococcus* in healthy women. *J. Infect. Dis.* **182**:1129-1138.
12. **Baker, C. J., L. C. Paoletti, M. A. Rench, H. K. Guttormsen, M. S. Edwards, and D. L. Kasper.** 2004. Immune response of healthy women to two different type V group B streptococcal capsular polysaccharide-protein conjugate vaccines. *J. Infect. Dis.* **189**:1103-1112.
13. **Baker, C. J., L. C. Paoletti, M. R. Wessels, H. K. Guttormsen, M. A. Rench, M. E. Hickman, and D. L. Kasper.** 1999. Safety and immunogenicity of capsular polysaccharide-tetanus toxoid conjugate vaccines for group B streptococcal types Ia and Ib. *J. Infect. Dis.* **179**:142-150.
14. **Baker, C. J., M. A. Rench, and P. McInnes.** 2003. Immunization of pregnant women with group B streptococcal type III capsular polysaccharide-tetanus toxoid conjugate vaccine. *Vaccine* **21**:3468-3472.
15. **Baker, C. J., M. A. Rench, L. C. Paoletti, and M. S. Edwards.** 2007. Dose-response to type V group B streptococcal polysaccharide-tetanus toxoid conjugate vaccine in healthy adults. *Vaccine* **25**:55-63.
16. **Banerjee, R. V., and R. G. Matthews.** 1990. Cobalamin-dependent methionine synthase. *FASEB J* **4**:1450-1459.

17. **Barendt, S. M., L. T. Sham, and M. E. Winkler.** 2011. Characterization of mutants deficient in the L,D-carboxypeptidase (DacB) and WalRK (VicRK) regulon, involved in peptidoglycan maturation of *Streptococcus pneumoniae* serotype 2 strain D39. *J. Bacteriol.* **193**:2290-2300.
18. **Barnes, A. C., M. T. Horne, and A. E. Ellis.** 2003. *Streptococcus iniae* expresses a cell surface non-immune trout immunoglobulin-binding factor when grown in normal trout serum. *Fish Shellfish Immunol* **15**:425-431.
19. **Barnes, A. C., F. M. Young, M. T. Horne, and A. E. Ellis.** 2003. *Streptococcus iniae*: serological differences, presence of capsule and resistance to immune serum killing. *Dis Aquat Organ* **53**:241-247.
20. **Bera, A., R. Biswas, S. Herbert, and F. Gotz.** 2006. The presence of peptidoglycan O-acetyltransferase in various staphylococcal species correlates with lysozyme resistance and pathogenicity. *Infect Immun* **74**:4598-4604.
21. **Bera, A., S. Herbert, A. Jakob, W. Vollmer, and F. Gotz.** 2005. Why are pathogenic staphylococci so lysozyme resistant? The peptidoglycan O-acetyltransferase OatA is the major determinant for lysozyme resistance of *Staphylococcus aureus*. *Mol Microbiol* **55**:778-787.
22. **Bercovier, H., C. Ghittino, and A. Eldar.** 1997. Immunization with bacterial antigens: infections with streptococci and related organisms. *Dev Biol Stand* **90**:153-160.
23. **Berends, E. T., A. R. Horswill, N. M. Haste, M. Monestier, V. Nizet, and M. von Kockritz-Blickwede.** 2010. Nuclease expression by *Staphylococcus aureus* facilitates escape from neutrophil extracellular traps. *J Innate Immun* **2**:576-586.
24. **Bernard, E., T. Rolain, P. Courtin, A. Guillot, P. Langella, P. Hols, and M. P. Chartier.** 2011. Characterization of O-acetylation of N-acetylglucosamine: a novel structural variation of bacterial peptidoglycan. *J Biol Chem.*
25. **Berner, R.** 2004. Significance, management and prevention of *Streptococcus agalactiae* infection during the perinatal period. *Expert. Rev. Anti. Infect. Ther.* **2**:427-437.



26. **Berridge, B. R., J. D. Fuller, J. de Azavedo, D. E. Low, H. Bercovier, and P. F. Frelief.** 1998. Development of specific nested oligonucleotide PCR primers for the *Streptococcus iniae* 16S-23S ribosomal DNA intergenic spacer. *J Clin Microbiol* **36**:2778-2781.
27. **Bessen, D. E., J. Carapetis, B. Beall, R. Katz, M. Hibble, B. J. Currie, T. Collingridge, M. W. Izzo, D. A. Scaramuzzine, and K. S. Sriprakash.** 2000. Contrasting molecular epidemiology of group A streptococci causing tropical and nontropical infections of the skin and throat. *J. Infect. Dis.* **182**:1109-1116.
28. **Biswas, R., L. Voggu, U. K. Simon, P. Hentschel, G. Thumm, and F. Gotz.** 2006. Activity of the major staphylococcal autolysin Atl. *FEMS Microbiol Lett* **259**:260-268.
29. **Blackburn, N. T., and A. J. Clarke.** 2002. Characterization of soluble and membrane-bound family 3 lytic transglycosylases from *Pseudomonas aeruginosa*. *Biochemistry* **41**:1001-1013.
30. **Bolotin, S., J. D. Fuller, D. J. Bast, T. J. Beveridge, and J. C. de Azavedo.** 2007. Capsule expression regulated by a two-component signal transduction system in *Streptococcus iniae*. *FEMS Immunol Med Microbiol* **50**:366-374.
31. **Bolotin, S., J. D. Fuller, D. J. Bast, and J. C. de Azavedo.** 2007. The two-component system *sivS/R* regulates virulence in *Streptococcus iniae*. *FEMS Immunol. Med. Microbiol.* **51**:547-554.
32. **Boneca, I. G., O. Dussurget, D. Cabanes, M. A. Nahori, S. Sousa, M. Lecuit, E. Psylinakis, V. Bouriotis, J. P. Hugot, M. Giovannini, A. Coyle, J. Bertin, A. Namane, J. C. Rousselle, N. Cayet, M. C. Prevost, V. Balloy, M. Chignard, D. J. Philpott, P. Cossart, and S. E. Girardin.** 2007. A critical role for peptidoglycan N-deacetylation in *Listeria* evasion from the host innate immune system. *Proc Natl Acad Sci U S A* **104**:997-1002.
33. **Borregaard, N.** 2010. Neutrophils, from marrow to microbes. *Immunity* **33**:657-670.
34. **Borregaard, N., and J. B. Cowland.** 1997. Granules of the human neutrophilic polymorphonuclear leukocyte. *Blood* **89**:3503-3521.

35. **Brandt, E. R., W. A. Hayman, B. Currie, J. Carapetis, Y. Wood, D. C. Jackson, J. Cooper, W. D. Melrose, A. J. Saul, and M. F. Good.** 1996. Opsonic human antibodies from an endemic population specific for a conserved epitope on the M protein of group A streptococci. *Immunology* **89**:331-337.
36. **Brandt, E. R., K. S. Sriprakash, R. I. Hobb, W. A. Hayman, W. Zeng, M. R. Batzloff, D. C. Jackson, and M. F. Good.** 2000. New multi-determinant strategy for a group A streptococcal vaccine designed for the Australian Aboriginal population. *Nat. Med.* **6**:455-459.
37. **Brinkmann, V., U. Reichard, C. Goosmann, B. Fauler, Y. Uhlemann, D. S. Weiss, Y. Weinrauch, and A. Zychlinsky.** 2004. Neutrophil extracellular traps kill bacteria. *Science* **303**:1532-1535.
38. **Brodeur, B. R., M. Boyer, I. Charlebois, J. Hamel, F. Couture, C. R. Rioux, and D. Martin.** 2000. Identification of group B streptococcal Sip protein, which elicits cross-protective immunity. *Infect Immun* **68**:5610-5618.
39. **Bromage, E. S., and L. Owens.** 2002. Infection of barramundi *Lates calcarifer* with *Streptococcus iniae*: effects of different routes of exposure. *Dis Aquat Organ* **52**:199-205.
40. **Bronze, M. S., and J. B. Dale.** 1993. Epitopes of streptococcal M proteins that evoke antibodies that cross-react with human brain. *J. Immunol.* **151**:2820.
41. **Brunt, J., and B. Austin.** 2005. Use of a probiotic to control lactococcosis and streptococcosis in rainbow trout, *Oncorhynchus mykiss* (Walbaum). *J Fish Dis* **28**:693-701.
42. **Bryan, J. D., R. Liles, U. Cvek, M. Trutschl, and D. Shelver.** 2008. Global transcriptional profiling reveals *Streptococcus agalactiae* genes controlled by the MtaR transcription factor. *BMC Genomics* **9**:607-619.
43. **Buchanan, J. T., K. M. Colvin, M. R. Vicknair, S. K. Patel, A. M. Timmer, and V. Nizet.** 2008. Strain-associated virulence factors of *Streptococcus iniae* in hybrid-striped bass. *Vet. Microbiol.* **131**:145-153.

44. **Buchanan, J. T., J. A. Stannard, X. Lauth, V. E. Ostland, H. C. Powell, M. E. Westerman, and V. Nizet.** 2005. *Streptococcus iniae* phosphoglucomutase is a virulence factor and a target for vaccine development. *Infect. Immun.* **73**:6935-6944.
45. **Buchanan, J. T., J. A. Stannard, X. Lauth, V. E. Ostland, H. C. Powell, M. E. Westerman, and V. Nizet.** 2005. *Streptococcus iniae* phosphoglucomutase is a virulence factor and a target for vaccine development. *Infect. Immun.* **73**:6935-6944.
46. **Butler, M. G., S. Isogai, and B. M. Weinstein.** 2009. Lymphatic development. *Birth Defects Res C Embryo Today* **87**:222-231.
47. **Cai, X. Y., M. E. Maxon, B. Redfield, R. Glass, N. Brot, and H. Weissbach.** 1989. Methionine synthesis in *Escherichia coli*: effect of the MetR protein of *metE* and *metH* expression. *Proc. Natl. Acad. Sci.* **86**:4407-4411.
48. **Campanelli, D., M. Melchior, Y. Fu, M. Nakata, H. Shuman, C. Nathan, and J. E. Gabay.** 1990. Cloning of cDNA for proteinase 3: a serine protease, antibiotic, and autoantigen from human neutrophils. *J Exp Med* **172**:1709-1715.
49. **Campbell, J. R., S. L. Hillier, M. A. Krohn, P. Ferrieri, D. F. Zaleznik, and C. J. Baker.** 2000. Group B streptococcal colonization and serotype-specific immunity in pregnant women at delivery. *Obstet. Gynecol.* **96**:498-503.
50. **Carapetis, J. R., A. C. Steer, E. K. Mulholland, and M. Weber.** 2005. The global burden of group A streptococcal disease. *Lancet Infect. Dis.* **5**:685-694.
51. **Carroll, S. A., T. Hain, U. Technow, A. Darji, P. Pashalidis, S. W. Joseph, and T. Chakraborty.** 2003. Identification and characterization of a peptidoglycan hydrolase, MurA, of *Listeria monocytogenes*, a muramidase needed for cell separation. *J. Bacteriol.* **23**:6801-6808.
52. **CDC.** 2005. Vaccine preventable deaths and the global immunization vision strategy, 2006-1015. *MMWR Morb. Mortal. Wkly. Rep.* **55**:511-515.

53. **Centers\_for\_Disease\_Control\_and\_Prevention.** 2010. Invasive pneumococcal disease in young children before licensure of 13-valent pneumococcal conjugate vaccine - United States, 2007. *MMWR Morb Mortal Wkly Rep* **59**:253-257.
54. **Chan, J., and J. D. Mably.** 2011. Dissection of cardiovascular development and disease pathways in zebrafish. *Prog Mol Biol Transl Sci* **100**:111-153.
55. **Chan, K. G., M. Mayer, E. M. Davis, S. A. Halperin, T. J. Lin, and S. F. Lee.** 2007. Role of D-alanylation of *Streptococcus gordonii* lipoteichoic acid in innate and adaptive immunity. *Infect Immun* **75**:3033-3042.
56. **Chang, A., A. Khemlani, H. Kang, and T. Proft.** 2011. Functional analysis of *Streptococcus pyogenes* nuclease A (SpnA), a novel group A streptococcal virulence factor. *Mol Microbiol* **79**:1629-1642.
57. **Chatterjee, J., C. M. Miyamoto, A. Zouzoulas, B. F. Lang, N. Skouris, and E. A. Meighen.** 2002. MetR and CRP bind to the *Vibrio harveyi* lux promoters and regulate luminescence. *Mol. Microbiol.* **46**:101-111.
58. **Cheng, S., Y. H. Hu, X. D. Jiao, and L. Sun.** 2010. Identification and immunoprotective analysis of a *Streptococcus iniae* subunit vaccine candidate. *Vaccine* **28**:2636-2641.
59. **Chidiac, C., and F. Ader.** 2009. Pneumococcal vaccine in the elderly: a useful but forgotten vaccine. *Aging Clin Exp Res* **21**:222-228.
60. **Chirwa, N. T., and M. B. Herrington.** 2004. Role of MetR and PurR in the activation of glyA by CsgD in *Escherichia coli* K-12. *Can J Microbiol* **50**:683-690.
61. **Clark, C. S., and A. T. Maurelli.** 2007. *Shigella flexneri* inhibits staurosporine-induced apoptosis in epithelial cells. *Infect Immun* **75**:2531-2539.
62. **Clatworthy, A. E., J. S. Lee, M. Leibman, Z. Kostun, A. J. Davidson, and D. T. Hung.** 2009. *Pseudomonas aeruginosa* infection of zebrafish involves both host and pathogen determinants. *Infect Immun* **77**:1293-1303.

63. **Cole, A., H. Liao, O. Stuchlik, J. Tilan, J. Pohl, and T. Ganz.** 2002. Cationic polypeptides are required for antibacterial activity of human airway fluid. *J Immunol* **169**:6985-6991.
64. **Commichau, F. M., F. M. Rothe, C. Herzberg, E. Wagner, D. Hellwig, M. Lehnik-Habrink, E. Hammer, U. Volker, and J. Stulke.** 2009. Novel activities of glycolytic enzymes in *Bacillus subtilis*: interactions with essential proteins involved in mRNA processing. *Mol Cell Proteomics* **8**:1350-1360.
65. **Cowan, J. M., M. L. Urbanowski, M. Talmi, and G. V. Stauffer.** 1993. Regulation of the *Salmonella typhimurium* metF gene by the MetR protein. *J. Bacteriol.* **175**:5862-5866.
66. **Cramer, E., and J. Breton-Gorius.** 1987. Ultrastructural localization of lysozyme in human neutrophils by immunogold. *J Leukoc Biol* **41**:242-247.
67. **Crater, D. L., and I. van de Rijn.** 1995. Hyaluronic acid synthesis operon (has) expression in group A streptococci. *J Biol Chem* **270**:18452-18458.
68. **Crisostomo, M. I., W. Vollmer, A. S. Kharat, S. Inhulsen, F. Gehre, S. Buckenmaier, and A. Tomasz.** 2006. Attenuation of penicillin resistance in a peptidoglycan O-acetyl transferase mutant of *Streptococcus pneumoniae*. *Mol Microbiol* **61**:1497-1509.
69. **Cunningham, M. W.** 2008. Pathogenesis of group A streptococcal infections and their sequelae. *Adv Exp Med Biol* **609**:29-42.
70. **Dagan, R.** 2009. Impact of pneumococcal conjugate vaccine on infections caused by antibiotic-resistant *Streptococcus pneumoniae*. *Clin Microbiol Infect* **15 Suppl 3**:16-20.
71. **Dahm, R., and R. Geisler.** 2006. Learning from small fry: the zebrafish as a genetic model organism for aquaculture fish species. *Mar Biotechnol (NY)* **8**:329-345.
72. **Dale, J. B., and E. H. Beachey.** 1985. Multiple heart-cross-reactive epitopes of streptococcal M proteins. *J. Exp. Med.* **161**:113-122.

73. **Dale, J. B., E. Y. Chiang, D. L. Hasty, and H. S. Courtney.** 2002. Antibodies against a synthetic peptide of SagA neutralize the cytolytic activity of streptolysin S from group A streptococci. *Infect. Immun.* **70**:2166-2170.
74. **Dalebroux, Z. D., S. L. Svensson, E. C. Gaynor, and M. S. Swanson.** 2010. ppGpp conjures bacterial virulence. *Microbiol Mol Biol Rev* **74**:171-199.
75. **Davis, J. M., and L. Ramakrishnan.** 2009. The role of the granuloma in expansion and dissemination of early tuberculous infection. *Cell* **136**:37-49.
76. **de Crecy-Lagard, V., B. El Yacoubi, R. D. de la Garza, A. Noiriél, and A. D. Hanson.** 2007. Comparative genomics of bacterial and plant folate synthesis and salvage: predictions and validations. *BMC Genomics* **8**:245.
77. **Denault, J. B., and G. S. Salvesen.** 2002. Caspases: keys in the ignition of cell death. *Chem Rev* **102**:4489-4500.
78. **Dermer, P., C. Lee, J. Eggert, and B. Few.** 2004. A history of neonatal group B streptococcus with its related morbidity and mortality rates in the United States. *J. Pediatr. Nurs.* **19**:357-363.
79. **Draper, B. W., C. M. McCallum, J. L. Stout, A. J. Slade, and C. B. Moens.** 2004. A high-throughput method for identifying N-ethyl-N-nitrosourea (ENU)-induced point mutations in zebrafish. *Methods Cell Biol* **77**:91-112.
80. **Draper, B. W., P. A. Morcos, and C. B. Kimmel.** 2001. Inhibition of zebrafish *fgf8* pre-mRNA splicing with morpholino oligos: a quantifiable method for gene knockdown. *Genesis* **30**:154-156.
81. **Drevets, D. A.** 1999. Dissemination of *Listeria monocytogenes* by infected phagocytes. *Infect. Immun.* **67**:3512-3517.
82. **Drummond, J. T., and R. G. Matthews.** 1993. Cobalamin-dependent and cobalamin-independent methionine synthases in *Escherichia coli*: two solutions to the same chemical problem. *Adv Exp Med Biol* **338**:687-692.

83. **Edwards, M. S., and C. J. Baker.** 2005. Group B streptococcal infections in elderly adults. *Clin. Infect. Dis.* **41**:839-847.
84. **Edwards, M. S., M. A. Rench, A. A. Haffar, M. A. Murphy, M. M. Desmond, and C. J. Baker.** 1985. Long-term sequelae of group B streptococcal meningitis in infants. *J. Pediatr.* **106**:717-722.
85. **Eimon, P. M., and A. Ashkenazi.** 2010. The zebrafish as a model organism for the study of apoptosis. *Apoptosis* **15**:331-349.
86. **Eisen, J. S., and J. C. Smith.** 2008. Controlling morpholino experiments: don't stop making antisense. *Development* **135**:1735-1743.
87. **Eisenreich, W., T. Dandekar, J. Heesemann, and W. Goebel.** 2010. Carbon metabolism of intracellular bacterial pathogens and possible links to virulence. *Nat. Rev. Microbiol.* **8**:401-412.
88. **Eldar, A., Y. Bejerano, A. Livoff, A. Horovitz, and H. Bercovier.** 1995. Experimental streptococcal meningo-encephalitis in cultured fish. *Vet. Microbiol.* **43**.
89. **Eldar, A., P. F. Frelief, L. Asanta, P. W. Varner, S. Lawhorn, and H. Bercovier.** 1995. *Streptococcus shiloi*, the name for an agent causing septicemic infection in fish, is a junior synonym of *Streptococcus iniae*. *Int. J. Syst. Bacteriol.* **45**.
90. **Eldar, A., A. Horovitz, and H. Bercovier.** 1997. Development and efficacy of a vaccine against *Streptococcus iniae* infection in farmed rainbow trout. *Vet Immunol Immunopathol* **56**:175-183.
91. **Eldholm, V., B. Gutt, O. Johnsborg, R. Bruckner, P. Maurer, R. Hakenbeck, T. Mascher, and L. S. Havarstein.** 2010. The pneumococcal cell envelope stress-sensing system LiaFSR is activated by murein hydrolases and lipid II-interacting antibiotics. *J Bacteriol* **192**:1761-1773.
92. **Ernst, C. M., P. Staubitz, N. N. Mishra, S. J. Yang, G. Hornig, H. Kalbacher, A. S. Bayer, D. Kraus, and A. Peschel.** 2009. The bacterial defensin resistance protein MprF consists of

separable domains for lipid lysinylation and antimicrobial peptide repulsion. *PLoS Pathog* **5**:e1000660.

93. **Eyngor, M., A. Lublin, R. Shapira, A. Hurvitz, A. Zlotkin, Y. Tekoah, and A. Eldar.** 2010. A pivotal role for the *Streptococcus iniae* extracellular polysaccharide in triggering proinflammatory cytokines transcription and inducing death in rainbow trout. *FEMS Microbiol Lett* **305**:109-120.
94. **Eyngor, M., Y. Tekoah, R. Shapira, A. Hurvitz, A. Zlotkin, A. Lublin, and A. Eldar.** 2008. Emergence of novel *Streptococcus iniae* exopolysaccharide-producing strains following vaccination with nonproducing strains. *Appl Environ Microbiol* **74**:6892-6897.
95. **Facklam, R., J. Elliott, L. Shewmaker, and A. Reingold.** 2005. Identification and characterization of sporadic isolates of *Streptococcus iniae* isolated from humans. *J. Clin. Microbiol.* **43**:933-937.
96. **Farley, M. M.** 2001. Group B streptococcal disease in nonpregnant adults. *Clin Infect Dis* **33**:556-561.
97. **Farley, M. M.** 2001. Group B streptococcal disease in nonpregnant adults. *Clin. Infect. Dis.* **33**:556-561.
98. **Faurschou, M., and N. Borregaard.** 2003. Neutrophil granules and secretory vesicles in inflammation. *Microbes Infect* **5**:1317-1327.
99. **Fischetti, V. A., K. F. Jones, and J. R. Scott.** 1985. Size variation of the M protein in group A streptococci. *J. Exp. Med.* **161**:1384-1401.
100. **Fittipaldi, N., T. Sekizaki, D. Takamatsu, J. Harel, L. Dominguez-Punaro Mde, S. Von Aulock, C. Draing, C. Marois, M. Kobisch, and M. Gottschalk.** 2008. D-alanylation of lipoteichoic acid contributes to the virulence of *Streptococcus suis*. *Infect Immun* **76**:3587-3594.



101. **Fuller, J. D., D. J. Bast, V. Nizet, D. E. Low, and J. C. de Azavedo.** 2001. *Streptococcus iniae* virulence is associated with a distinct genetic profile. *Infect. Immun.* **69**:1994-2000.
102. **Fuller, J. D., A. C. Camus, C. L. Duncan, V. Nizet, D. J. Bast, R. L. Thune, D. E. Low, and J. C. De Azavedo.** 2002. Identification of a streptolysin S-associated gene cluster and its role in the pathogenesis of *Streptococcus iniae* disease. *Infect Immun* **70**:5730-5739.
103. **Gal, J., A. Szvetnik, R. Schnell, and M. Kalman.** 2002. The metD D-methionine transporter locus of *Escherichia coli* is an ABC transporter gene cluster. *J Bacteriol* **184**:4930-4932.
104. **Ganz, T.** 2003. Defensins: antimicrobial peptides of innate immunity. *Nat Rev Immunol* **3**:710-720.
105. **Gao, L. Y., and Y. A. Kwaik.** 2000. The modulation of host cell apoptosis by intracellular bacterial pathogens. *Trends Microbiol* **8**:306-313.
106. **Garcia, D. L., and J. P. Dillard.** 2006. AmiC functions as an *N*-acetylmuramyl-L-alanine amidase necessary for cell separation and can promote autolysis in *Neisseria gonorrhoeae*. *J. Bacteriol.* **188**:7211-7221.
107. **Gibbs, R. S., S. J. Schrag, and A. Schuchat.** 2004. Perinatal infections due to group B streptococci. *Obstet. Gynecol.* **104**:1062-1076.
108. **Gibello, A., M. D. Collins, L. Dominguez, J. Fernandez-Garayzabal, and P. T. Richardson.** 1999. Cloning and analysis of the L-Lactate utilization genes from *Streptococcus iniae*. *Appl. Environ. Microbiol.* **65**:4346-4350.
109. **Goh, S. H., D. Driedger, S. Gillett, D. E. Low, S. M. Hemmingsen, M. Amos, D. Chan, M. Lovgren, B. M. Willey, C. Shaw, and J. A. Smith.** 1998. *Streptococcus iniae*, a human and animal pathogen: specific identification by the chaperonin 60 gene identification method. *J Clin Microbiol* **36**:2164-2166.

110. **Gresham, H. D., J. H. Lowrance, T. E. Caver, B. S. Wilson, A. L. Cheung, and F. P. Lindberg.** 2000. Survival of *Staphylococcus aureus* inside neutrophils contributes to infection. *J. Immunol.* **164**:3713-3722.
111. **Guenzy, E., A. M. Gasc, M. A. Sicard, and R. Hakenbeck.** 1994. A two component signal-transducing system is involved in competence and penicillin susceptibility in laboratory mutants of *Streptococcus pneumoniae*. *Mol. Microbiol.* **12**:505-515.
112. **Guimaraes-Costa, A. B., M. T. Nascimento, G. S. Froment, R. P. Soares, F. N. Morgado, F. Conceicao-Silva, and E. M. Saraiva.** 2009. Leishmania amazonensis promastigotes induce and are killed by neutrophil extracellular traps. *Proc Natl Acad Sci U S A* **106**:6748-6753.
113. **Gyaneshwar, P., O. Paliy, J. McAuliffe, A. Jones, M. I. Jordan, and S. Kustu.** 2005. Lessons from *Escherichia coli* genes similarly regulated in response to nitrogen and sulfur limitation. *Proc. Natl. Acad. Sci.* **102**:3453-3458.
114. **Haas, W., D. Kaushal, J. Sublett, C. Obert, and E. I. Tuomanen.** 2005. Vancomycin stress response in a sensitive and a tolerant strain of *Streptococcus pneumoniae*. *J Bacteriol* **187**:8205-8210.
115. **Halfmann, A., M. Kovacs, R. Hakenbeck, and R. Bruckner.** 2007. Identification of the genes directly controlled by the response regulator CiaR in *Streptococcus pneumoniae*: five out of 15 promoters drive expression of small non-coding RNAs. *Mol Microbiol* **66**:110-126.
116. **Hanski, E., P. A. Horwitz, and M. G. Caparon.** 1992. Expression of protein F, the fibronectin-binding protein of *Streptococcus pyogenes* JRS4, in heterologous streptococcal and enterococcal strains promotes their adherence to respiratory epithelial cells. *Infect Immun* **60**:5119-5125.
117. **Hanson, B. R., B. A. Lowe, and M. N. Neely.** 2011. Membrane topology and DNA-binding ability of the Streptococcal CpsA protein. *J Bacteriol* **193**:411-420.

118. **Hausdorff, W. P., J. Bryant, P. R. Paradiso, and G. R. Siber.** 2000. Which pneumococcal serogroups cause the most invasive disease: implications for conjugate vaccine formulation and use, part I. *Clin. Infect. Dis.* **30**:100-121.
119. **Hawser, S., S. Lociuro, and K. Islam.** 2006. Dihydrofolate reductase inhibitors as antibacterial agents. *Biochem Pharmacol* **71**:941-948.
120. **Hayashi, K.** 1975. A rapid determination of sodium dodecyl sulfate with methylene blue. *Anal Biochem* **67**:503-506.
121. **Hebert, L., P. Courtin, R. Torelli, M. Sanguinetti, M. P. Chapot-Chartier, Y. Auffray, and A. Benachour.** 2007. *Enterococcus faecalis* constitutes an unusual bacterial model in lysozyme resistance. *Infect Immun* **75**:5390-5398.
122. **Heckman, C. A., J. W. Mehew, and L. M. Boxer.** 2002. NF-kappaB activates Bcl-2 expression in t(14:18) lymphoma cells. *Oncogene* **21**:3898-3908.
123. **Heelan, J. S., M. E. Hasenbein, and A. J. McAdam.** 2004. Resistance of group B streptococcus to selected antibiotics, including erythromycin and clindamycin. *J. Clin. Microbiol.* **42**:1263-1264.
124. **Heidrich, C., M. F. Templin, A. Ursinus, M. Merdanovic, J. Berger, H. Schwarz, M. A. de Pedro, and J. V. Holtje.** 2001. Involvement of *N*-acetyl-muramyl-L-alanine amidases in cell separation and antibiotic-induced autolysis of *Escherichia coli*. *Mol. Microbiol.* **41**:167-178.
125. **Heidrich, C., A. Ursinus, J. Berger, H. Schwarz, and J. V. Holtje.** 2002. Effects of multiple deletions of murein hydrolases on viability, septum cleavage, and sensitivity to large toxic molecules in *Escherichia coli*. *J. Bacteriol.* **184**:6093-6099.
126. **Herbert, S., A. Bera, C. Nerz, D. Kraus, A. Peschel, C. Goerke, M. Meehl, A. Cheung, and F. Gotz.** 2007. Molecular basis of resistance to muramidase and cationic antimicrobial peptide activity of lysozyme in staphylococci. *PLoS Pathog* **3**:e102.

127. **Hermann, A. C., and C. H. Kim.** 2005. Effects of arsenic on zebrafish innate immune system. *Mar Biotechnol (NY)* **7**:494-505.
128. **Hicks, L. A., L. H. Harrison, B. Flannery, J. L. Hadler, W. Schaffner, A. S. Craig, D. Jackson, A. Thomas, B. Beall, R. Lynfield, A. Reingold, M. M. Farley, and C. G. Whitney.** 2007. Incidence of pneumococcal disease due to non-pneumococcal conjugate vaccine (PCV7) serotypes in the United States during the era of widespread PCV7 vaccination, 1998-2004. *J. Infect. Dis.* **196**:1346-1354.
129. **Hoog, C., A. Rotondo, B. D. Johnston, and B. M. Pinto.** 2002. Synthesis and conformational analysis of a pentasaccharide corresponding to the cell-wall polysaccharide of group A streptococcus. *Carbohydr. Res.* **337**:2023-2036.
130. **Hu, M. C., M. A. Walls, S. D. Stroop, M. A. Reddish, B. Beall, and J. B. Dale.** 2002. Immunogenicity of a 26-valent group A streptococcal vaccine. *Infect. Immun.* **70**:2171-2177.
131. **Huang, C. J., T. S. Jou, Y. L. Ho, W. H. Lee, Y. T. Jeng, F. J. Hsieh, and H. J. Tsai.** 2005. Conditional expression of a myocardium-specific transgene in zebrafish transgenic lines. *Dev Dyn* **233**:1294-1303.
132. **Hubbard, S., N. A. Darmani, G. R. Thrush, D. Dey, L. Burnham, J. M. Thompson, K. Jones, and V. Tiwari.** 2010. Zebrafish-encoded 3-O-sulfotransferase-3 isoform mediates herpes simplex virus type 1 entry and spread. *Zebrafish* **7**:181-187.
133. **Isaacman, D. J., E. D. McIntosh, and R. R. Reinert.** 2010. Burden of invasive pneumococcal disease and serotype distribution among *Streptococcus pneumoniae* isolates in young children in Europe: impact of the 7-valent pneumococcal conjugate vaccine and considerations for future conjugate vaccines. *Int J Infect Dis* **14**:e197-209.
134. **Iyer, R., N. S. Baliga, and A. Camilli.** 2005. Catabolite control protein A (CcpA) contributes to virulence and regulation of sugar metabolism in *Streptococcus pneumoniae*. *J. Bacteriol.* **187**:8340-8349.

135. **Jabado, N., A. Jankowski, S. Dougaparsad, V. Picard, S. Grinstein, and P. Gros.** 2000. Natural resistance to intracellular infections: natural resistance-associated macrophage protein 1 (Nramp1) functions as a pH-dependent manganese transporter at the phagosomal membrane. *J Exp Med* **192**:1237-1248.
136. **Ji, Y., B. Carlson, A. Kondagunta, and P. P. Cleary.** 1997. Intranasal immunization with C5a peptidase prevents nasopharyngeal colonization of mice by the group A streptococcus. *Infect. Immun.* **65**:2080-2087.
137. **Johri, A. K., L. C. Paoletti, P. Glaser, M. Dua, P. K. Sharma, G. Grandi, and R. Rappuoli.** 2006. Group B Streptococcus: global incidence and vaccine development. *Nat Rev Microbiol* **4**:932-942.
138. **Jones, K. F., S. K. Hollingshead, J. R. Scott, and V. A. Fischetti.** 1988. Spontaneous M6 protein size mutants of group A streptococci display variation in antigenic and opsonogenic epitopes. *Proc. Natl. Acad. Sci.* **85**:8271-8275.
139. **Jordan, S., E. Rietkotter, M. A. Strauch, F. Kalamorz, B. G. Butcher, J. D. Helmann, and T. Mascher.** 2007. LiaRS-dependent gene expression is embedded in transition state regulation in *Bacillus subtilis*. *Microbiology* **153**:2530-2540.
140. **Juneau, R. A., B. Pang, K. E. Weimer, C. E. Armbruster, and W. E. Swords.** 2011. Nontypeable *Haemophilus influenzae* initiates formation of neutrophil extracellular traps. *Infect Immun* **79**:431-438.
141. **Kabashi, E., E. Brustein, N. Champagne, and P. Drapeau.** 2011. Zebrafish models for the functional genomics of neurogenetic disorders. *Biochim Biophys Acta* **1812**:335-345.
142. **Kadioglu, A., J. N. Weiser, J. C. Paton, and P. W. Andrew.** 2008. The role of *Streptococcus pneumoniae* virulence factors in host respiratory colonization and disease. *Nat. Rev. Microbiol.* **6**:288-301.

143. **Kadner, R. J.** 1974. Transport systems for L-methionine in *Escherichia coli*. *J Bacteriol* **117**:232-241.
144. **Kanai, K., M. Notohara, T. Kato, K. Shutou, and K. Yoshikoshi.** 2006. Serological characterization of *Streptococcus iniae* strains isolated from cultured fish in Japan. *Fish Path.* **41**:57-66.
145. **Kang, S. O., M. G. Caparon, and K. H. Cho.** 2010. Virulence gene regulation by CvfA, a putative RNase: the CvfA-enolase complex in *Streptococcus pyogenes* links nutritional stress, growth-phase control, and virulence gene expression. *Infect. Immun.* **78**:2754-2767.
146. **Kaplan, E. L., J. T. Wotton, and D. R. Johnson.** 2001. Dynamic epidemiology of group A streptococcal serotypes associated with pharyngitis. *Lancet* **358**:1334-1337.
147. **Kawasaki, T., K. Saito, K. Mitsui, M. Ikawa, M. Yamashita, Y. Taniguchi, S. Takeda, K. Mitani, and N. Sakai.** 2009. Introduction of a foreign gene into zebrafish and medaka cells using adenoviral vectors. *Zebrafish* **6**:253-258.
148. **Kietzman, C. C., and M. G. Caparon.** 2010. CcpA and LacD.1 affect temporal regulation of *Streptococcus pyogenes* virulence genes. *Infect Immun.* **78**:241-252.
149. **Kietzman, C. C., and M. G. Caparon.** 2011. Distinct time-resolved roles for two catabolite-sensing pathways during *Streptococcus pyogenes* infection. *Infect Immun* **79**:812-821.
150. **Kimura, K., S. Suzuki, J. Wachino, H. Kurokawa, K. Yamane, N. Shibata, N. Nagano, H. Kato, K. Shibayama, and Y. Arakawa.** 2008. First molecular characterization of group B streptococci with reduced penicillin susceptibility. *Antimicrob. Agents Chemother.* **52**:2890-2897.
151. **Kimura, K., S. Suzuki, J. Wachino, H. Kurokawa, K. Yamane, N. Shibata, N. Nagano, H. Kato, K. Shibayama, and Y. Arakawa.** 2008. First Molecular characterization of group B streptococci with reduced penicillin susceptibility. *Antimicrob. Agents Chemother.* doi:10.1128/AAC.00185-08.

152. **Kishi, S., B. E. Slack, J. Uchiyama, and I. V. Zhdanova.** 2009. Zebrafish as a genetic model in biological and behavioral gerontology: where development meets aging in vertebrates--a mini-review. *Gerontology* **55**:430-441.
153. **Kizy, A. E., and M. N. Neely.** 2009. First *Streptococcus pyogenes* signature-tagged mutagenesis screen identifies novel virulence determinants. *Infect Immun* **77**:1854-1865.
154. **Kjeldsen, L., D. F. Bainton, H. Sengelov, and N. Borregaard.** 1994. Identification of neutrophil gelatinase-associated lipocalin as a novel matrix protein of specific granules in human neutrophils. *Blood* **83**:799-807.
155. **Klebanoff, S. J.** 1999. Myeloperoxidase. *Proc Assoc Am Physicians* **111**:383-389.
156. **Koskiniemi, S., M. Sellin, and M. Norgren.** 1998. Identification of two genes, *cpsX* and *cpsY*, with putative regulatory function on capsule expression in group B streptococci. *FEMS Immunol. Med. Microbiol.* **21**:159-168.
157. **Kovacs, M., A. Halfmann, I. Fedtke, M. Heintz, A. Peschel, W. Vollmer, R. Hakenbeck, and R. Bruckner.** 2006. A functional *dlt* operon, encoding proteins required for incorporation of d-alanine in teichoic acids in gram-positive bacteria, confers resistance to cationic antimicrobial peptides in *Streptococcus pneumoniae*. *J Bacteriol* **188**:5797-5805.
158. **Kovaleva, G. Y., and M. S. Gelfand.** 2007. Transcriptional regulation of the methionine and cysteine transport and metabolism in streptococci. *FEMS Microbiol. Lett.* **276**:207-215.
159. **Kramer, N. E., H. E. Hasper, P. T. van den Bogaard, S. Morath, B. de Kruijff, T. Hartung, E. J. Smid, E. Breukink, J. Kok, and O. P. Kuipers.** 2008. Increased D-alanylation of lipoteichoic acid and a thickened septum are main determinants in the nisin resistance mechanism of *Lactococcus lactis*. *Microbiology* **154**:1755-1762.
160. **Kraus, D., S. Herbert, S. A. Kristian, A. Khosravi, V. Nizet, F. Gotz, and A. Peschel.** 2008. The GraRS regulatory system controls *Staphylococcus aureus* susceptibility to antimicrobial host defenses. *BMC Microbiol* **8**:85.

161. **Kristian, S. A., V. Datta, C. Weidenmaier, R. Kansal, I. Fedtke, A. Peschel, R. L. Gallo, and V. Nizet.** 2005. D-alanylation of teichoic acids promotes group a streptococcus antimicrobial peptide resistance, neutrophil survival, and epithelial cell invasion. *J Bacteriol* **187**:6719-6725.
162. **Kristian, S. A., M. Durr, J. A. Van Strijp, B. Neumeister, and A. Peschel.** 2003. MprF-mediated lysinylation of phospholipids in *Staphylococcus aureus* leads to protection against oxygen-independent neutrophil killing. *Infect Immun* **71**:546-549.
163. **Kroemer, G., and J. C. Reed.** 2000. Mitochondrial control of cell death. *Nat. Med.* **6**:513-519.
164. **Kuroda, M., H. Kuroda, T. Oshima, F. Takeuchi, H. Mori, and K. Hiramatsu.** 2003. Two-component system *VraSR* positively modulates the regulation of cell-wall biosynthesis pathway in *Staphylococcus aureus*. *Mol Microbiol* **49**:807-821.
165. **Kvitt, H., and A. Colorni.** 2004. Strain variation and geographic endemism in *Streptococcus iniae*. *Dis Aquat Organ* **61**:67-73.
166. **Laaberki, M. H., J. Pfeffer, A. J. Clarke, and J. Dworkin.** 2011. O-Acetylation of peptidoglycan is required for proper cell separation and S-layer anchoring in *Bacillus anthracis*. *J Biol Chem* **286**:5278-5288.
167. **Lam, S. H., H. L. Chua, Z. Gong, T. J. Lam, and Y. M. Sin.** 2004. Development and maturation of the immune system in zebrafish, *Danio rerio*: a gene expression profiling, in situ hybridization and immunological study. *Dev Comp Immunol* **28**:9-28.
168. **Lam, S. H., H. L. Chua, Z. Gong, Z. Wen, T. J. Lam, and Y. M. Sin.** 2002. Morphologic transformation of the thymus in developing zebrafish. *Dev Dyn* **225**:87-94.
169. **LaMonte, B. L., and J. A. Hughes.** 2006. In vivo hydrolysis of *S*-adenosylmethionine induces the met regulon of *Escherichia coli*. *Microbiol.* **152**:1451-1459.
170. **Lau, S. K., P. C. Woo, W. K. Luk, A. M. Fung, W. T. Hui, A. H. Fong, C. W. Chow, S. S. Wong, and K. Y. Yuen.** 2006. Clinical isolates of *Streptococcus iniae* from Asia are more



- mucoid and beta-hemolytic than those from North America. *Diagn. Microbiol. Infect. Dis.* **54**:177-181.
171. **Lau, S. K., P. C. Woo, H. Tse, K. W. Leung, S. S. Wong, and K. Y. Yuen.** 2003. Invasive *Streptococcus iniae* infections outside North America. *J Clin Microbiol* **41**:1004-1009.
172. **Lee, W. L., R. E. Harrison, and S. Grinstein.** 2003. Phagocytosis by neutrophils. *Microbes Infect* **5**:1299-1306.
173. **Li, J., C. Tan, Y. Zhou, S. Fu, L. Hu, J. Hu, H. Chen, and W. Bei.** 2010. The two-component regulatory system CiaRH contributes to the virulence of *Streptococcus suis* 2. *Vet Microbiol.*
174. **Li, S. Y., J. V. Holtje, and K. D. Young.** 2004. Comparison of high-performance liquid chromatography and fluorophore-assisted carbohydrate electrophoresis methods for analyzing peptidoglycan composition of *Escherichia coli*. *Anal Biochem* **326**:1-12.
175. **Li, Y., A. Karlin, J. D. Loike, and S. C. Silverstein.** 2002. A critical concentration of neutrophils is required for effective bacterial killing in suspension. *Proc. Natl. Acad. Sci.* **99**:8289-8294.
176. **Li, Y., B. Sun, H. Wu, and P. Nie.** 2009. Effects of pure microcystin-LR on the transcription of immune related genes and heat shock proteins in larval stage of zebrafish (*Danio rerio*). *Aquaculture* **289**:154-160.
177. **Lieschke, G. J., A. C. Oates, M. O. Crowhurst, A. C. Ward, and J. E. Layton.** 2001. Morphologic and functional characterization of granulocytes and macrophages in embryonic and adult zebrafish. *Blood* **98**:3087-3096.
178. **Liu, S., and S. D. Leach.** 2011. Zebrafish models for cancer. *Annu Rev Pathol* **6**:71-93.
179. **Llull, D., R. Lopez, and E. Garcia.** 2001. Genetic bases and medical relevance of capsular polysaccharide biosynthesis in pathogenic streptococci. *Curr Mol Med* **1**:475-491.

180. **Locke, J. B., R. K. Aziz, M. R. Vicknair, V. Nizet, and J. T. Buchanan.** 2008. *Streptococcus iniae* M-like protein contributes to virulence in fish and is a target for live attenuated vaccine development. PLoS One **3**:e2824.
181. **Locke, J. B., K. M. Colvin, N. Varki, M. R. Vicknair, V. Nizet, and J. T. Buchanan.** 2007. *Streptococcus iniae* beta-hemolysin streptolysin S is a virulence factor in fish infection. Dis. Aquat. Organ. **76**:17-26.
182. **Locke, J. B., K. M. MColvin, A. K. Datta, S. K. Patel, N. N. Naidu, M. N. Neely, V. Nizet, and J. T. Buchanan.** 2007. *Streptococcus iniae* capsule impairs phagocytic clearance and contributes to virulence in fish. J. Bacteriol. **189**:1279-1287.
183. **Lorenz, E., and G. V. Stauffer.** 1995. Characterization of the MetR binding sites for the *glyA* gene of *Escherichia coli*. J. Bacteriol. **177**:4113-4120.
184. **Lowe, B. A.** 2007. Analysis of the Systemic Dissemination of the Zoonotic Pathogen *Streptococcus iniae* and the Importance of Capsule. Doctor of Philosophy. Wayne State University, Detroit, MI.
185. **Lowe, B. A., J. D. Miller, and M. N. Neely.** 2007. Analysis of the polysaccharide capsule of the systemic pathogen *Streptococcus iniae* and its implications in virulence. Infect. Immun. **75**:1255-1264.
186. **Lu, S. C.** 2000. S-Adenosylmethionine. Int J Biochem Cell Biol **32**:391-395.
187. **Luhrmann, A., and C. R. Roy.** 2007. *Coxiella burnetii* inhibits activation of host cell apoptosis through a mechanism that involves preventing cytochrome c release from mitochondria. Infect Immun **75**:5282-5289.
188. **Lynskey, N. N., R. A. Lawrenson, and S. Sriskandan.** 2011. New understandings in *Streptococcus pyogenes*. Curr Opin Infect Dis **24**:196-202.

189. **Lyon, W. R., C. M. Gibson, and M. G. Caparon.** 1998. A role for trigger factor and an rgg-like regulator in the transcription, secretion and processing of the cysteine proteinase of *Streptococcus pyogenes*. *EMBO J.* **17**:6263-6275.
190. **Maden, B. E.** 2000. Tetrahydrofolate and tetrahydromethanopterin compared: functionally distinct carriers in C1 metabolism. *Biochem J* **350 Pt 3**:609-629.
191. **Malech, H. L., and W. M. Nauseef.** 1997. Primary inherited defects in neutrophil function: etiology and treatment. *Semin. Hematol.* **34**:279-290.
192. **Malke, H., K. Steiner, W. M. McShan, and J. J. Ferretti.** 2006. Linking the nutritional status of *Streptococcus pyogenes* to alteration of transcriptional gene expression: the action of CodY and RelA. *Int. J. Med. Microbiol.* **296**:259-275.
193. **Margarit, I., C. D. Rinaudo, C. L. Galeotti, D. Maione, C. Ghezzi, E. Buttazzoni, R. Rosini, Y. Runci, M. Mora, S. Buccato, M. Pagani, E. Tresoldi, A. Berardi, R. Creti, C. J. Baker, J. L. Telford, and G. Grandi.** 2009. Preventing bacterial infections with pilus-based vaccines: the group B streptococcus paradigm. *J Infect Dis* **199**:108-115.
194. **Mata, A., M. Mar Blanco, L. Dominguez, J. Fernandez-Garayzabal, and A. Gibello.** 2004. Development of a PCR assay for *Streptococcus iniae* based on the lactate oxidase (*lctO*) gene with potential diagnostic value. *Vet. Microbiol.* **101**:109-116.
195. **McCormick, A., L. Heesemann, J. Wagener, V. Marcos, D. Hartl, J. Loeffler, J. Heesemann, and F. Ebel.** 2010. NETs formed by human neutrophils inhibit growth of the pathogenic mold *Aspergillus fumigatus*. *Microbes Infect* **12**:928-936.
196. **Medina, E., M. Rohde, and G. S. Chhatwal.** 2003. Intracellular survival of *Streptococcus pyogenes* in polymorphonuclear cells results in increased bacterial virulence. *Infect. Immun.* **71**:5376-5380.
197. **Meeker, N. D., and N. S. Trede.** 2008. Immunology and zebrafish: spawning new models of human disease. *Dev Comp Immunol* **32**:745-757.

198. **Meijer, A. H., S. F. Gabby Krens, I. A. Medina Rodriguez, S. He, W. Bitter, B. Ewa Snaar-Jagalska, and H. P. Spaink.** 2004. Expression analysis of the Toll-like receptor and TIR domain adaptor families of zebrafish. *Mol Immunol* **40**:773-783.
199. **Meyrand, M., A. Boughammoura, P. Courtin, C. Mezange, A. Guillot, and M. P. Chapot-Chartier.** 2007. Peptidoglycan N-acetylglucosamine deacetylation decreases autolysis in *Lactococcus lactis*. *Microbiology* **153**:3275-3285.
200. **Milani, C. J., R. K. Aziz, J. B. Locke, S. Dahesh, V. Nizet, and J. T. Buchanan.** 2010. The novel polysaccharide deacetylase homologue Pdi contributes to virulence of the aquatic pathogen *Streptococcus iniae*. *Microbiol.* **156**:543-554.
201. **Miller, J. D.** 2005. Large scale screen highlights the importance of capsule for the systemic zoonotic pathogen, *Streptococcus iniae*. Ph.D. Wayne State University, Detroit, MI.
202. **Miller, J. D., and M. N. Neely.** 2005. Large-scale screen highlights the importance of capsule for virulence in the zoonotic pathogen *Streptococcus iniae*. *Infect. Immun.* **73**:921-934.
203. **Miller, J. D., and M. N. Neely.** 2004. Zebrafish as a model host for streptococcal pathogenesis. *Acta Tropica* **91**:53-68.
204. **Moon, A. F., M. Midon, G. Meiss, A. Pingoud, R. E. London, and L. C. Pedersen.** 2011. Structural insights into catalytic and substrate binding mechanisms of the strategic EndA nuclease from *Streptococcus pneumoniae*. *Nucleic Acids Res* **39**:2943-2953.
205. **Moscoso, M., M. Domenech, and E. Garcia.** 2010. Vancomycin tolerance in clinical and laboratory *Streptococcus pneumoniae* isolates depends on reduced enzyme activity of the major LytA autolysin or cooperation between CiaH histidine kinase and capsular polysaccharide. *Mol Microbiol.*
206. **Moynihan, P. J., and A. J. Clarke.** 2010. O-acetylation of peptidoglycan in gram-negative bacteria: identification and characterization of peptidoglycan O-acetyltransferase in *Neisseria gonorrhoeae*. *J Biol Chem* **285**:13264-13273.

207. **Mullaney, D. M.** 2001. Group B streptococcal infections in newborns. *J. Obstet. Gynecol. Neonatal Nurs.* **30**:649-658.
208. **Murayama, E., K. Kissa, A. Zapata, E. Mordelet, V. Briolat, H. F. Lin, R. I. Handin, and P. Herbomel.** 2006. Tracing hematopoietic precursor migration to successive hematopoietic organs during zebrafish development. *Immunity* **25**:963-975.
209. **Nascimento, M. M., J. A. Lemos, J. Abranches, V. K. Lin, and R. A. Burne.** 2008. Role of RelA of *Streptococcus mutans* in global control of gene expression. *J. Bacteriol.* **190**:28-36.
210. **Nasevicius, A., and S. C. Ekker.** 2000. Effective targeted gene 'knockdown' in zebrafish. *Nat Genet* **26**:216-220.
211. **Nash, J. A., T. N. Ballard, T. E. Weaver, and H. T. Akinbi.** 2006. The peptidoglycan-degrading property of lysozyme is not required for bactericidal activity in vivo. *J Immunol* **177**:519-526.
212. **Nawawi, R. A., J. C. F. Baiano, E. C. E. Kvennefors, and A. C. Barnes.** 2009. Host-directed evolution of a novel lactate oxidase in *Streptococcus iniae* isolates from barramundi (*Lates calcarifer*). *Appl Environ Microbiol* **75**:2908-2919.
213. **Nayak, A. S., C. R. Lage, and C. H. Kim.** 2007. Effects of low concentrations of arsenic on the innate immune system of the zebrafish (*Danio rerio*). *Toxicol Sci* **98**:118-124.
214. **Neely, M. N., J. Pfeifer, and M. G. Capron.** 2002. Streptococcus-zebrafish model of bacterial pathogenesis. *Infect. Immun.* **70**:3904-3914.
215. **Neely, M. N., J. D. Pfeifer, and M. Caparon.** 2002. Streptococcus-zebrafish model of bacterial pathogenesis. *Infect. Immun.* **70**:3904-3914.
216. **Neron, B., H. Menager, C. Maufrais, N. Joly, J. Maupetit, S. Letort, S. Carrere, P. Tuffery, and C. Letondal.** 2009. Mobylye: a new full web bioinformatics framework. *Bioinformatics* **25**:3005-3011.

217. **Oram, J. D., and B. Reiter.** 1968. Inhibition of bacteria by lactoferrin and other iron-chelating agents. *Biochim Biophys Acta* **170**:351-365.
218. **Ortqvist, A., J. Hedlund, and M. Kalin.** 2005. *Streptococcus pneumoniae*: epidemiology, risk factors, and clinical features. *Semin Respir Crit Care Med* **26**:563-574.
219. **Paik, E. J., and L. I. Zon.** 2010. Hematopoietic development in the zebrafish. *Int J Dev Biol* **54**:1127-1137.
220. **Palazzi, D. L., M. A. Rench, M. S. Edwards, and C. J. Baker.** 2004. Use of type V group B streptococcal conjugate vaccine in adults 65-85 years old. *J. Infect. Dis.* **190**:558-564.
221. **Pan, X., H. Wan, W. Chia, Y. Tong, and Z. Gong.** 2005. Demonstration of site-directed recombination in transgenic zebrafish using the Cre/loxP system. *Transgenic Res* **14**:217-223.
222. **Papayannopoulos, V., and A. Zychlinsky.** 2009. NETs: a new strategy for using old weapons. *Trends Immunol* **30**:513-521.
223. **Patton, E. E., D. L. Mitchell, and R. S. Nairn.** 2010. Genetic and environmental melanoma models in fish. *Pigment Cell Melanoma Res* **23**:314-337.
224. **Payie, K. G., H. Strating, and A. J. Clarke.** 1996. The role of O-acetylation in the metabolism of peptidoglycan in *Providencia stuartii*. *Microb Drug Resist* **2**:135-140.
225. **Peschel, A., R. W. Jack, M. Otto, L. V. Collins, P. Staubitz, G. Nicholson, H. Kalbacher, W. F. Nieuwenhuizen, G. Jung, A. Tarkowski, K. P. van Kessel, and J. A. van Strijp.** 2001. *Staphylococcus aureus* resistance to human defensins and evasion of neutrophil killing via the novel virulence factor MprF is based on modification of membrane lipids with l-lysine. *J Exp Med* **193**:1067-1076.
226. **Pfeffer, J. M., H. Strating, J. T. Weadge, and A. J. Clarke.** 2006. Peptidoglycan O acetylation and autolysin profile of *Enterococcus faecalis* in the viable but nonculturable state. *J Bacteriol* **188**:902-908.

227. **Pfoh, E., M. R. Wessels, D. Goldmann, and G. M. Lee.** 2008. Burden and economic cost of group A streptococcal pharyngitis. *Pediatrics* **121**:229-234.
228. **Phares, C. R., R. Lynfield, M. M. Farley, J. Mohle-Boetani, L. H. Harrison, S. Petit, A. S. Craig, W. Schaffner, S. M. Zansky, K. Gershman, K. R. Stefonek, B. A. Albanese, E. R. Zell, A. Schuchat, and S. J. Schrag.** 2008. Epidemiology of invasive group B streptococcal disease in the United States, 1999-2005. *Jama* **299**:2056-2065.
229. **Phares, C. R., R. Lynfield, M. M. Farley, J. C. Mohle-Boetani, L. H. Harrison, S. Petit, A. S. Craig, W. Schaffner, S. M. Zansky, K. Gershman, K. R. Stefonek, B. A. Albanese, E. R. Zell, A. Schuchat, and S. J. Schrag.** 2008. Epidemiology of invasive group B streptococcal disease in the United States, 1999-2005. *JAMA* **299**:2056-2065.
230. **Phennicie, R. T., M. J. Sullivan, J. T. Singer, J. A. Yoder, and C. H. Kim.** 2010. Specific resistance to *Pseudomonas aeruginosa* infection in zebrafish is mediated by the cystic fibrosis transmembrane conductance regulator. *Infect Immun* **78**:4542-4550.
231. **Pier, G. B., and S. H. Madin.** 1976. *Streptococcus iniae* sp. nov., a Beta-hemolytic streptococcus isolated from an amazon freshwater dolphin, *Iniae geoffrensis*. *Int. J. Syst. Bacteriol.* **26**:545-553.
232. **Pier, G. B., S. H. Madin, and S. Al-Nakeeb.** 1978. Isolation and characterization of a second isolate of *Streptococcus iniae*. *Int. J. Syst. Bacteriol.* **28**:311-314.
233. **Pietiainen, M., P. Francois, H. L. Hyrylainen, M. Tangomo, V. Sass, H. G. Sahl, J. Schrenzel, and V. P. Kontinen.** 2009. Transcriptome analysis of the responses of *Staphylococcus aureus* to antimicrobial peptides and characterization of the roles of *vraDE* and *vraSR* in antimicrobial resistance. *BMC Genomics* **10**:429.
234. **Plamann, M. D., and G. V. Stauffer.** 1989. Regulation of the *Escherichia coli glyA* gene by the *metR* gene product and homocysteine. *J. Bacteriol.* **171**:4958-4962.

235. **Poyart, C., E. Pellegrini, M. Marceau, M. Baptista, F. Jaubert, M. C. Lamy, and P. Trieu-Cuot.** 2003. Attenuated virulence of *Streptococcus agalactiae* deficient in D-alanyl-lipoteichoic acid is due to an increased susceptibility to defensins and phagocytic cells. *Mol Microbiol* **49**:1615-1625.
236. **Pressley, M. E., P. E. Phelan, 3rd, P. E. Witten, M. T. Mellon, and C. H. Kim.** 2005. Pathogenesis and inflammatory response to *Edwardsiella tarda* infection in the zebrafish. *Dev Comp Immunol* **29**:501-513.
237. **Priyadarshini, R., D. L. Popham, and K. D. Young.** 2006. Daughter cell separation by penicillin-binding proteins and peptidoglycan amidases in *Escherichia coli*. *J. Bacteriol.* **188**:5345-5355.
238. **Pruksakorn, S., B. Currie, E. Brandt, D. Martin, A. Galbraith, C. Phornphutkul, S. Hunsakunachai, A. Manmontri, and M. F. Good.** 1994. Towards a vaccine for rheumatic fever: identification of a conserved target epitope on M protein of group A streptococci. *Lancet* **344**:639-642.
239. **Pruksakorn, S., N. Sittisombut, C. Phornphutkul, C. Pruksachatkunakorn, and M. F. Good.** 2000. Epidemiological analysis of non-M-typeable group A streptococcus isolates from a Thai population in northern Thailand. *J. Clin. Microbiol.* **38**:1334-1337.
240. **Quach, D., N. M. van Sorge, S. A. Kristian, J. D. Bryan, D. W. Shelver, and K. S. Doran.** 2009. The CiaR response regulator in group B *Streptococcus* promotes intracellular survival and resistance to innate immune defenses. *J. Bacteriol.* **191**:2023-2032.
241. **Ramanathan, B., E. G. Davis, C. R. Ross, and F. Blecha.** 2002. Cathelicidins: microbicidal activity, mechanisms of action, and roles in innate immunity. *Microbes Infect* **4**:361-372.
242. **Raschke, W. C., S. Baird, P. Ralph, and I. Nakoinz.** 1978. Functional macrophage cell lines transformed by Abelson leukemia virus. *Cell* **15**:261-267.



243. **Reddy, R. C., and T. J. Standiford.** 2010. Effects of sepsis on neutrophil chemotaxis. *Curr Opin Hematol* **17**:18-24.
244. **Remijsen, Q., T. Vanden Berghe, E. Wirawan, B. Asselbergh, E. Parthoens, R. De Rycke, S. Noppen, M. Delforge, J. Willems, and P. Vandenabeele.** 2011. Neutrophil extracellular trap cell death requires both autophagy and superoxide generation. *Cell Res* **21**:290-304.
245. **Rice, K. C., and K. W. Bayles.** 2008. Molecular control of bacterial death and lysis. *Microbiol. Mol. Biol. Rev.* **72**:85-109.
246. **Rinkwitz, S., P. Mourrain, and T. S. Becker.** 2011. Zebrafish: an integrative system for neurogenomics and neurosciences. *Prog Neurobiol* **93**:231-243.
247. **Robinson, J. A., and F. P. Meyer.** 1966. Streptococcal fish pathogen. *J Bacteriol* **92**:512.
248. **Rodionov, D. A., A. G. Vitreschak, A. A. Mironov, and M. S. Gelfand.** 2004. Comparative genomics of the methionine metabolism in Gram-positive bacteria: a variety of regulatory systems. *Nucl. Acids Res.* **32**:3340-3353.
249. **Romao, S., G. Memi, M. R. Oggioni, and M. C. Trombe.** 2006. LuxS impacts on LytA-dependent autolysis and on competence in *Streptococcus pneumoniae*. *Microbiol* **152**:333-341.
250. **Salvesen, G., D. Farley, J. Shuman, A. Przybyla, C. Reilly, and J. Travis.** 1987. Molecular cloning of human cathepsin G: structural similarity to mast cell and cytotoxic T lymphocyte proteinases. *Biochemistry* **26**:2289-2293.
251. **Samant, S., F. F. Hsu, and H. Lee.** 2008. The *Bacillus anthracis* MprF is required for synthesis of lysylphosphatidylglycerols and for resistance to cationic antimicrobial peptides. *J Bacteriol* **191**:1311-1319.
252. **Samore, M. H., M. K. Magill, S. C. Alder, E. Severina, L. Morrison-De Boer, J. L. Lyon, K. Carroll, J. Leary, M. B. Stone, D. Bradford, J. Reading, A. Tomasz, and M. A. Sande.** 2001. High rates of multiple antibiotic resistance in *Streptococcus pneumoniae* from healthy

- children living in isolated rural communities: association with cephalosporin use and intrafamilial transmission. *Pediatrics* **108**:856-865.
253. **Sartorius, U., I. Schmitz, and P. H. Krammer.** 2001. Molecular mechanisms of death-receptor-mediated apoptosis. *Chembiochem* **2**:20-29.
254. **Schell, M. A.** 1993. Molecular Biology of the LysR Family of Transcriptional Regulators. *Annu Rev Microbiol* **47**:597-626.
255. **Schrag, S. J., S. Zywicki, M. M. Farley, A. L. Reingold, L. H. Harrison, L. B. Lefkowitz, J. L. Hadler, R. Danila, P. R. Cieslak, and A. Schuchat.** 2000. Group B streptococcal disease in the era of intrapartum antibiotic prophylaxis. *N. Engl. J. Med.* **342**:15-20.
256. **Segal, A. W.** 2005. How neutrophils kill microbes. *Annu Rev Immunol* **23**:197-223.
257. **Sekowska, A., H. F. Kung, and A. Danchin.** 2000. Sulfur metabolism in *Escherichia coli* and related bacteria: facts and fiction. *J Mol Microbiol Biotechnol* **2**:145-177.
258. **Sendi, P., L. Johansson, and A. Norrby-Teglund.** 2008. Invasive Group B Streptococcal Disease in Non-pregnant Adults : A Review with Emphasis on Skin and Soft-tissue Infections. *Infection* **36**:100-111.
259. **Shelver, D., L. Rajagopal, T. O. Harris, and C. E. Rubens.** 2003. MtaR, a regulator of methionine transport, is critical for survival of group B streptococcus in vivo. *J. Bacteriol.* **185**:6592-6599.
260. **Shoemaker, C. A., P. H. Klesius, and J. J. Evans.** 2001. Prevalence of *Streptococcus iniae* in tilapia, hybrid striped bass, and channel catfish on commercial fish farms in the United States. *Am J Vet Res* **62**:174-177.
261. **Shouval, D. S., D. Greenberg, N. Givon-Lavi, N. Porat, and R. Dagan.** 2006. Site-specific disease potential of individual *Streptococcus pneumoniae* serotypes in pediatric invasive disease, acute otitis media and acute conjunctivitis. *Pediatr. Infect. Dis. j.* **25**:602-607.

262. **Shutou, K., K. Kanai, and K. Yoshikoshi.** 2007. Virulence attenuation of capsular polysaccharide-deleted mutants of *Streptococcus iniae* in Japanese flounder *Paralichthys olivaceus*. *Fish Path.* **42**:41-48.
263. **Simoës, J. A., A. A. Aroutcheva, I. Heimler, and S. Faro.** 2004. Antibiotic resistance patterns of group B streptococcal clinical isolates. *Infect. Dis. Obstet. Gynecol.* **12**:1-8.
264. **Sinha, S., W. Watorek, S. Karr, J. Giles, W. Bode, and J. Travis.** 1987. Primary structure of human neutrophil elastase. *Proc Natl Acad Sci U S A* **84**:2228-2232.
265. **Somerville, G. A., and R. A. Proctor.** 2009. At the crossroads of bacterial metabolism and virulence factor synthesis in *Staphylococci*. *Microbiol. Mol. Biol. Rev.* **73**:233-248.
266. **Sonenshein, A. L.** 2005. CodY, a global regulator of stationary phase and virulence in Gram-positive bacteria. *Curr Opin Microbiol* **8**:203-207.
267. **Sorensen, O. E., P. Follin, A. H. Johnsen, J. Calafat, G. S. Tjabringa, P. S. Hiemstra, and N. Borregaard.** 2001. Human cathelicidin, hCAP-18, is processed to the antimicrobial peptide LL-37 by extracellular cleavage with proteinase 3. *Blood* **97**:3951-3959.
268. **Sperandio, B., C. Gautier, S. McGovern, D. S. Ehrlich, P. Renault, I. Martin-Verstraete, and E. Guedon.** 2007. Control of methionine synthesis and uptake by MetR and homocysteine in *Streptococcus mutans*. *J Bacteriol* **189**:7032-7044.
269. **Staal, L., S. Bauer, M. Morgelin, L. Bjorck, and H. Tapper.** 2006. *Streptococcus pyogenes* bacteria modulate membrane traffic in human neutrophils and selectively inhibit azurophilic granule fusion with phagosomes. *Cell Microbiol* **8**:690-703.
270. **Steer, A. C., M. R. Batzloff, K. Mulholland, and J. R. Carapetis.** 2009. Group A streptococcal vaccines: facts versus fantasy. *Curr Opin Infect Dis* **22**:544-552.
271. **Stein, C., M. Caccamo, G. Laird, and M. Leptin.** 2007. Conservation and divergence of gene families encoding components of innate immune response systems in zebrafish. *Genome Biol* **8**:R251.

272. **Steiner, K., and H. Malke.** 2001. *relA*-independent amino acid starvation response network of *Streptococcus pyogenes*. J. Bacteriol. **183**:7354-7364.
273. **Stemple, D. L.** 2004. TILLING--a high-throughput harvest for functional genomics. Nat Rev Genet **5**:145-150.
274. **Stockhammer, O. W., A. Zakrzewska, Z. Hegedus, H. P. Spaink, and A. H. Meijer.** 2009. Transcriptome profiling and functional analyses of the zebrafish embryonic innate immune response to Salmonella infection. J Immunol **182**:5641-5653.
275. **Sukumaran, S. K., S. K. Selvaraj, and N. V. Prasadarao.** 2004. Inhibition of apoptosis by *Escherichia coli* K1 is accompanied by increased expression of BclXL and blockade of mitochondrial cytochrome c release in macrophages. Infect Immun **72**:6012-6022.
276. **Sullivan, C., and C. H. Kim.** 2008. Zebrafish as a model for infectious disease and immune function. Fish Shellfish Immunol **25**:341-350.
277. **Sun, J. R., J. C. Yan, C. Y. Yeh, S. Y. Lee, and J. J. Lu.** 2007. Invasive infection with *Streptococcus iniae* in Taiwan. J Med Microbiol **56**:1246-1249.
278. **Sun, Y., Y. H. Hu, C. S. Liu, and L. Sun.** 2010. Construction and analysis of an experimental *Streptococcus iniae* DNA vaccine. Vaccine **28**:3905-3912.
279. **Suntharalingam, P., M. D. Senadheera, R. W. Mair, C. M. Levesque, and D. G. Cvitkovitch.** 2009. The LiaFSR system regulates the cell envelope stress response in *Streptococcus mutans*. J Bacteriol **191**:2973-2984.
280. **Talbird, S. E., T. N. Taylor, J. Caporale, A. S. Ismaila, and J. Gomez.** 2010. Residual economic burden of *Streptococcus pneumoniae*- and nontypeable *Haemophilus influenzae*-associated disease following vaccination with PCV-7: a multicountry analysis. Vaccine **28** Suppl 6:G14-22.

281. **Taylor, S. L., L. Jaso-Friedmann, A. B. Allison, A. Eldar, and D. L. Evans.** 2001. Streptococcus iniae inhibition of apoptosis of nonspecific cytotoxic cells: a mechanism of activation of innate immunity in teleosts. *Dis Aquat Organ* **46**:15-21.
282. **Terao, Y., Y. Mori, M. Yamaguchi, Y. Shimizu, K. Ooe, S. Hamada, and S. Kawabata.** 2008. Group A streptococcal cysteine protease degrades C3 (C3b) and contributes to evasion of innate immunity. *J Biol Chem* **283**:6253-6260.
283. **Thedieck, K., T. Hain, W. Mohamed, B. J. Tindall, M. Nimtz, T. Chakraborty, J. Wehland, and L. Jansch.** 2006. The MprF protein is required for lysinylation of phospholipids in listerial membranes and confers resistance to cationic antimicrobial peptides (CAMPs) on *Listeria monocytogenes*. *Mol Microbiol* **62**:1325-1339.
284. **Traver, D., P. Herbomel, E. E. Patton, R. D. Murphey, J. A. Yoder, G. W. Litman, A. Catic, C. T. Amemiya, L. I. Zon, and N. S. Trede.** 2003. The zebrafish as a model organism to study development of the immune system. *Adv Immunol* **81**:253-330.
285. **Trede, N. S., D. M. Langenau, D. Traver, A. T. Look, and L. I. Zon.** 2004. The use of zebrafish to understand immunity. *Immunity* **20**:367-379.
286. **Uehara, T., K. R. Parzych, T. Dinh, and T. G. Bernhardt.** 2010. Daughter cell separation is controlled by cytokinetic ring-activated cell wall hydrolases. *EMBO J* **29**:1412-1422.
287. **Ulett, G. C., K. H. Maclean, S. Nekkhalapu, J. L. Cleveland, and E. E. Adderson.** 2005. Mechanisms of group B streptococcal-induced apoptosis of murine macrophages. *J Immunol* **175**:2555-2562.
288. **Urban, C. F., D. Ermert, M. Schmid, U. Abu-Abed, C. Goosmann, W. Nacken, V. Brinkmann, P. R. Jungblut, and A. Zychlinsky.** 2009. Neutrophil extracellular traps contain calprotectin, a cytosolic protein complex involved in host defense against *Candida albicans*. *PLoS Pathog* **5**:e1000639.

289. **Urban, C. F., S. Lourido, and A. Zychlinsky.** 2006. How do microbes evade neutrophil killing? *Cell Microbiol* **8**:1687-1696.
290. **Urbanowski, M. L., and G. V. Stauffer.** 1989. Role of homocysteine in MetR-mediated activation of the *metE* and *metH* genes in *Salmonella typhimurium* and *Escherichia coli*. *J. Bacteriol.* **171**:3277-3281.
291. **Urbanowski, M. L., L. T. Stauffer, L. S. Plamann, and G. V. Stauffer.** 1987. A new methionine locus, MetR, that encodes a trans-acting protein required for activation of *metE* and *metH* in *Escherichia coli* and *Salmonella typhimurium*. *J. Bacteriol.* **169**:1391-1397.
292. **Valentin-Weigand, P., S. R. Talay, A. Kaufhold, K. N. Timmis, and G. S. Chhatwal.** 1994. The fibronectin binding domain of the Sfb protein adhesin of *Streptococcus pyogenes* occurs in many group A streptococci and does not cross-react with heart myosin. *Microb. Pathog.* **17**:111-120.
293. **van der Poll, T., and S. M. Opal.** 2008. Host-pathogen interactions in sepsis. *Lancet Infect. Dis.* **8**:32-43.
294. **Veiga, P., C. Bulbarela-Sampieri, S. Furlan, A. Maisons, M. P. Chapot-Chartier, M. Erkelenz, P. Mervelet, P. Noirot, D. Frees, O. P. Kuipers, J. Kok, A. Gruss, G. Buist, and S. Kulakauskas.** 2007. SpxB regulates O-acetylation-dependent resistance of *Lactococcus lactis* peptidoglycan to hydrolysis. *J Biol Chem* **282**:19342-19354.
295. **Vojtech, L. N., G. E. Sanders, C. Conway, V. Ostland, and J. D. Hansen.** 2009. Host immune response and acute disease in a zebrafish model of *Francisella* pathogenesis. *Infect Immun* **77**:914-925.
296. **Volkman, H. E., H. Clay, D. Beery, J. C. Chang, D. R. Sherman, and L. Ramakrishnan.** 2004. Tuberculous granuloma formation is enhanced by a mycobacterium virulence determinant. *PLoS Biol* **2**:e367.

297. **Volkman, H. E., T. C. Pozos, J. Zheng, J. M. Davis, J. F. Rawls, and L. Ramakrishnan.** 2010. Tuberculous granuloma induction via interaction of a bacterial secreted protein with host epithelium. *Science* **327**:466-469.
298. **Vollmer, W., and A. Tomasz.** 2002. Peptidoglycan N-acetylglucosamine deacetylase, a putative virulence factor in *Streptococcus pneumoniae*. *Infect Immun* **70**:7176-7178.
299. **Vollmer, W., and A. Tomasz.** 2000. The *pgdA* gene encodes for a peptidoglycan N-acetylglucosamine deacetylase in *Streptococcus pneumoniae*. *J Biol Chem* **275**:20496-20501.
300. **Voyich, J. M., J. M. Musser, and F. R. DeLeo.** 2004. *Streptococcus pyogenes* and human neutrophils: a paradigm for evasion of innate host defense by bacterial pathogens. *Microbes Infect.* **6**:1117-1123.
301. **Wang, G., S. E. Maier, L. F. Lo, G. Maier, S. Dosi, and R. J. Maier.** 2010. Peptidoglycan deacetylation in *Helicobacter pylori* contributes to bacterial survival by mitigating host immune responses. *Infect Immun* **78**:4660-4666.
302. **Wecke, T., B. Veith, A. Ehrenreich, and T. Mascher.** 2006. Cell envelope stress response in *Bacillus licheniformis*: integrating comparative genomics, transcriptional profiling, and regulon mining to decipher a complex regulatory network. *J Bacteriol* **188**:7500-7511.
303. **Weinrauch, Y., and A. Zychlinsky.** 1999. The induction of apoptosis by bacterial pathogens. *Annu Rev Microbiol* **53**:155-187.
304. **Weinstein, M., D. Low, A. McGeer, B. Willey, D. Rose, M. Coulter, P. Wyper, A. Borczyk, M. Lovgren, and R. Facklam.** 1996. Invasive infection due to *Streptococcus iniae*: a new or previously unrecognized disease--Ontario, 1995-1996. *Can Commun Dis Rep* **22**:129-131; discussion 131-122.
305. **Weinstein, M. R., M. Litt, D. A. Kertesz, P. Wyper, D. Rose, M. Coulter, A. McGeer, R. Facklam, C. Ostach, B. M. Willey, A. Borczyk, and D. E. Low.** 1997. Invasive infections

- due to a fish pathogen, *Streptococcus iniae*. *S. iniae* Study Group. N. Engl. J. Med. **337**:589-594.
306. **Williams, A. E., and W. F. Blackemore.** 1990. Pathogenesis of meningitis caused by *Streptococcus suis* type2. J. Infect. Dis. **162**:474-481.
307. **Winzer, K., K. R. Hardie, and P. Williams.** 2003. LuxS and autoinducer-2: their contribution to quorum sensing and metabolism in bacteria. Adv. Appl. Microbiol. **53**:291-396.
308. **Woodfin, A., M. B. Voisin, and S. Nourshargh.** 2010. Recent developments and complexities in neutrophil transmigration. Curr Opin Hematol **17**:9-17.
309. **World\_Health\_Organization.** 2007. Pneumococcal conjugate vaccine for childhood immunization: WHO position paper. Wkly. Epidemiol. Rec. **82**:93-104.
310. **Xu, X., L. Zhang, S. Weng, Z. Huang, J. Lu, D. Lan, X. Zhong, X. Yu, A. Xu, and J. He.** 2008. A zebrafish (*Danio rerio*) model of infectious spleen and kidney necrosis virus (ISKNV) infection. Virology **376**:1-12.
311. **Yajima, A., Y. Takahashi, K. Shimazu, Y. Urano-Tashiro, Y. Uchikawa, H. Karibe, and K. Konishi.** 2009. Contribution of phosphoglucosamine mutase to the resistance of *Streptococcus gordonii* DL1 to polymorphonuclear leukocyte killing. FEMS Microbiol Lett **297**:196-202.
312. **Yeung, A. T., E. C. Torfs, F. Jamshidi, M. Bains, I. Wiegand, R. E. Hancock, and J. Overhage.** 2009. Swarming of *Pseudomonas aeruginosa* is controlled by a broad spectrum of transcriptional regulators, including MetR. J. Bacteriol. **191**:5592-5602.
313. **Yoon, H., J. E. McDermott, S. Porwollik, M. McClelland, and F. Heffron.** 2009. Coordinated regulation of virulence during systemic infection of *Salmonella enterica* serovar Typhimurium. PLoS Pathog. **5**:e1000306.
314. **Young, K. D.** 1996. A simple gel electrophoretic method for analyzing the muropeptide composition of bacterial peptidoglycan. J Bacteriol **178**:3962-3966.



315. **Zaleznik, D. F., M. A. Rench, S. L. Hillier, M. A. Krohn, R. Platt, M. L. Lee, A. E. Flores, P. Ferrieri, and C. J. Baker.** 2000. Invasive disease due to group B streptococcus in pregnant women and neonates from diverse population groups. *Clin. Infect. Dis.* **30**:276-281.
316. **Zhang, A., Y. Wu, H. W. L. Lai, and D. T. Yew.** 2004. Apoptosis - a brief review. *Neuro-embryology* **3**:47-59.
317. **Zhang, X., Z. W. El-Hajj, and E. Newman.** 2010. Deficiency in L-serine deaminase interferes with one-carbon metabolism and cell wall synthesis in *Escherichia coli* K-12. *J. Bacteriol.* **192**:5515-5525.
318. **Zlotkin, A., S. Chilmonczyk, M. Eynogor, A. Hurvitz, C. Ghittino, and A. Eldar.** 2003. Trojan horse effect: phagocyte-mediated *Streptococcus iniae* infection of fish. *Infect. Immun.* **71**:2318-2325.
319. **Zlotkin, A., A. Eldar, C. Ghittino, and H. Bercovier.** 1998. Identification of *Lactococcus garvieae* by PCR. *J Clin Microbiol* **36**:983-985.
320. **Zou, L., J. Wang, B. Huang, M. Xie, and A. Li.** 2011. MtsB, a hydrophobic membrane protein of *Streptococcus iniae*, is an effective subunit vaccine candidate. *Vaccine* **29**:391-394.

## ABSTRACT

PLEIOTROPIC REGULATORY FUNCTION OF THE LysR FAMILY TRANSCRIPTIONAL  
REGULATOR CpsY DURING *STREPTOCOCCUS INIAE* SYSTEMIC INFECTION

by

JONATHAN P. ALLEN

August 2011

**Advisor:** Dr. Melody Neely**Major:** Immunology and Microbiology**Degree:** Doctor of Philosophy

The ability of a pathogen to metabolically adapt to the local environment for optimal expression of virulence determinants is a continued area of research. Orthologs of the *Streptococcus iniae* LysR family regulator CpsY have been shown to regulate methionine biosynthesis and uptake pathways, but appear to influence expression of several virulence genes as well. A *S. iniae* mutant with an in-frame deletion of *cpsY* ( $\Delta cpsY$ ) is highly attenuated in a zebrafish infection model. The  $\Delta cpsY$  mutant displays a methionine-independent growth defect in serum, which differs from the methionine-dependent defect observed for orthologous mutants of *S. mutans* and *S. agalactiae*. On the contrary, the  $\Delta cpsY$  mutant can grow in excess of WT when supplemented with proteose peptone, suggesting an inability to properly regulate growth. CpsY is critical for protection of *S. iniae* from clearance by neutrophils in whole blood, but is dispensable for intracellular survival in macrophages. Susceptibility of the  $\Delta cpsY$  mutant to killing in whole blood is not due to a growth defect because inhibition of neutrophil phagocytosis rescues the mutant to WT levels. *S. iniae* does not alter neutrophil phagosomal maturation, but instead is able to adapt to the extreme bactericidal environment of a mature neutrophil phagosome dependent upon CpsY. This CpsY-dependent adaptation appears to involve stabilization of the cell wall in part through peptidoglycan *O*-acetylation and repression of cellular autolysins. In addition, CpsY may influence these processes by responding to nutritional

stress. The ability of a pathogen to evade neutrophil phagocytic killing mechanisms is critically important for dissemination and establishment of a systemic infection. Understanding how pathogens overcome these innate defenses is important for the development of optimal therapeutic strategies for invasive infections. Furthermore *S. iniae* proves to be a powerful model to investigate bacterial adaptations during systemic streptococcal infection.

## AUTOBIOGRAPHICAL STATEMENT

### EDUCATION

#### **Doctor of Philosophy, 2011**

Wayne State University School of Medicine

Major: Immunology and Microbiology

Advisor: Melody N. Neely, Ph.D.

Dissertation Title: Pleiotropic regulatory function of the LysR family transcriptional regulator CpsY during *Streptococcus iniae* systemic infection.

#### **Master of Science, 2006**

Western Michigan University

Major: Biological Sciences

Advisor: Silvia Rossbach, Ph.D.

Thesis Title: Changes in microbial community structure of petroleum contaminated sediments are reflected in subsurface geophysical signatures.

#### **Bachelor of Science, 2003**

Western Michigan University

Major: Biomedical Sciences

### HONORS

2011: University Dissertation Fellowship, Wayne State University.

2010: National Institutes of Health, Graduate Student Research Festival Recipient, Poster Presenter.

2007: Rumble Graduate Fellowship, Wayne State University.

2006: Michigan Chapter for the American Society of Microbiology, First Place Poster, Spring Meeting. Western Michigan University, Graduate Research and Creative Scholar Award (Teaching).

2005: Rutgers University Biogeophysics Travel Award for the AGU Joint Assembly Meeting.

Western Michigan University, Graduate Research and Creative Scholar Award (Research).

Western Michigan University, Monroe Brown Life Science Graduate Research Award.

2004: Western Michigan University, Graduate Student Research Award.

2004: Western Michigan University, Undergraduate Research and Creative Activities Award.

### PUBLICATIONS:

**Allen, J.P.**, Neely, M.N. (2011). The CpsY regulon influences *Streptococcus iniae* cell wall modification pathways necessary for neutrophil intracellular survival. In Preparation

**Allen, J.P.**, Neely, M.N. (2011). The *Streptococcus iniae* transcriptional regulator CpsY is required for protection from neutrophil-mediated killing and proper growth in vitro. In review, Infect Immun.

**Allen, J.P.**, Neely, M.N. (2010). Trolling for the ideal model host: zebrafish take the bait. Future Microbiol. 5:563-569.

Dezwaan, D.C., Mequio, M.J., Littell, J.S., **Allen, J.P.**, Rossbach, S., Pybus, V. (2007). Purification and characterization of enterocin 62-6, a two-peptide bacteriocin produced by a vaginal strain of *Enterococcus faecium*: Potential significance in bacterial vaginosis. Microb. Ecol. Health. Dis. 19:241-250.

**Allen, J.P.**, Atekwana, E.A., Atekwana, E.A., Duris, J.W., Werkema, D.D., Rossbach, S. (2007). The microbial community structure in petroleum-contaminated sediments corresponds to geophysical signatures. Appl. Environ. Microbiol. 73:2860-2870.

Atekwana, E.A., Atekwana, E.A., Werkema, D.D., **Allen, J.P.**, Smart, L.A., Duris, J.W., Cassidy, D.P., Sauck, W.A., Rossbach, S. (2004). Evidence for microbial enhanced electrical conductivity in hydrocarbon-contaminated sediments. Geophys. Res. Lett. 31:L23501.